

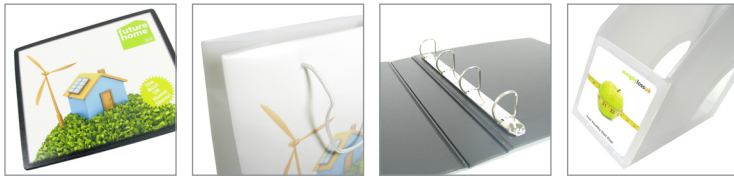

# create...



## Product Information

V3.6

01 February 2015

# create...

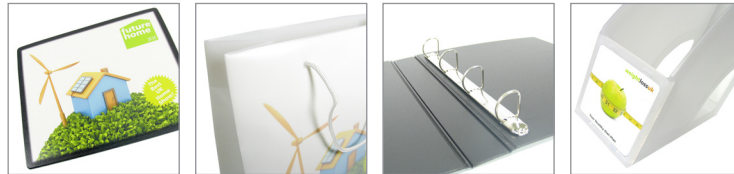

Xerox have developed a unique collection of presentation, display and promotional products for the print on demand industry which is called the 'Create' range.

Every product has the ability to have a printed sheet inserted to produce the over printing and titling of the product.

Using mostly recyclable materials such as polypropylene, the create range is environmentally friendly and many of the products can be recycled. However, the key advantage is that they are reusable thereby reducing landfill and saving money on reprinting conventional products.

There are currently 26 products in the range all available from stock in box quantities with many more designs being developed on an ongoing basis.

Because of its flexibility and unique performance, the create range has become an essential added value item, not a fashion trend and therefore we believe it will have a permanent position in the future.

The key advantages of the range are:

- Added value
- Flexibility
- Choice of products
- Multiple applications for every industry sector
- Fast production solution
- Innovative customisation options
- Increase your product offering
- Cost effective
- Ideal for long or short runs
- Light-weight and portable
- Available from stock

## Contents

### Ring Binders

A4 RING BINDER 2 x 40mm D RING 003R98884 003R98884 Specification Sheet	5
A4 X FILE RING BINDER 4 x 25mm D RING 003R98887 003R98887 Specification Sheet	7
A4 TUFF BINDER A4 POCKET 4 x 25mm D RING 003R98886 003R98886 Specification Sheet	9
A4 TUFF BINDER FULL POCKET 4 x 25mm D RING 003R98882 003R98882 Specification Sheet	11
A4 RING BINDER 4 x 11mm D RING 003R98874 003R98874 Specification Sheet	13
A4 BINDER 4 x 25mm D RING 003R98875 003R98875 Specification Sheet	15
A5 BINDER 2 x 35mm D RING 003R98885 003R98885 Specification Sheet	17
<b>Bags</b>	
BOUTIQUE BAG LARGE 003R98797	19
BOUTIQUE BAG LARGE INSERTS 003R92142 003R98797 Specification Sheet	20
BOUTIQUE BAG SMALL 003R98796	22
BOUTIQUE BAG SMALL INSERTS 003R92141 003R98796 Specification Sheet	23
BOUTIQUE BAG EXTRA SMALL 003R98876	25
BOUTIQUE BAG EXTRA SMALL INSERTS 003R92140 003R98876 Specification Sheet	26
BOTTLE GIFT BAG 003R95563	28
BOTTLE GIFT BAG INSERTS 003R91374 003R95563 Specification Sheet	29
<b>Desk Top &amp; Display</b>	
NAME PLATE DISPLAY 003R93575 003R93575 Specification Sheet	31
30cm RULER 003R98878 003R98878 Specification Sheet	33
SQUARE COASTER 003R98877 003R98877 Specification Sheet	35
MOUSE MAT 003R98798 003R98798 Specification Sheet	37
A3 COUNTER MAT 003R98883 003R98883 Specification Sheet	39

## Files & Folders

A4 WINDOW DISPLAY 003R95783 003R95783 Specification Sheet	41
A4 LEAFLET DISPENSER 003R98881 003R98881 Specification Sheet	43
FROSTED MAGAZINE FILE 003R98871 003R98871 Specification Sheet	45
FROSTED MAGAZINE FILE - ASSEMBLY INSTRUCTIONS 003R98871	47
A4 FLAT FOLDER 003R98799 003R98799 Specification Sheet	48
A4 FILE BOX 20mm CAPACITY 003R98873 003R98873 Specification Sheet	50
A4 FILE BOX 40mm CAPACITY 003R98872 003R98872 Specification Sheet	52
A4 COIL / WIRO COVER 003R98888 003R98888 Specification Sheet	54
A4 LETTER FILE 003R98879 003R98879 Specification Sheet	56
A4 LANDSCAPE FLAT FOLDER 003R93542 003R93542 Specification Sheet	58
A4 TOTEM DISPLAY UNIT 003R98880 003R98880 Specification Sheet	60
A3 TOTEM DISPLAY UNIT 003R95083 003R95083 Specification Sheet	62
iGEN TOTEM DISPLAY UNIT 003R95084 003R95084 Specification Sheet	64
900 TOTEM DISPLAY UNIT 003R95085 003R95085 Specification Sheet	66
900 TOTEM DISPLAY UNIT INSERT SHEETS 003R94998 003R94998 Specification Sheet	68
1200 TOTEM DISPLAY UNIT 003R95086 003R95086 Specification Sheet	70
1200 TOTEM DISPLAY UNIT INSERT SHEETS 003R94999 003R94999 Specification Sheet	72
1600 TOTEM DISPLAY UNIT 003R95087 003R95087 Specification Sheet	74

## Totems

## Samples

## Seeding Leaflets

003R98889 Sample Set Specification Sheet	
003R90001 FSDU Specification Sheet	
Sample Set & FSDU Specification Sheet	
SEEDING LEAFLET FRONT PAGE	79
SEEDING LEAFLET BACK PAGE	80
SEEDING LEAFLET BACK PAGE (EDITABLE)	81

<p><b>Description</b></p> <p><b>A4 RING BINDER 2 x 40mm D RING</b></p>	<p><b>This Box Contains</b></p> <p><b>x25 BINDERS</b></p> <p><b>x32 SHEETS</b></p> <p><b>(26 front inserts / 30 spine inserts)</b></p>
	<p><b>Cover Material</b></p> <p><b>Polypropylene</b></p>  <p><b>100% Recyclable</b></p>
	<p><b>Size</b></p> <p><b>268(w) x 310 (h) x 50(d)mm</b></p>

## Insert Sheet & Template

<p><b>Insert Sheet</b></p> <p>160gsm COLOUR IMPRESSIONS</p>	<p><b>Size</b></p> <p>210 x 297mm</p>	<p><b>Download template at</b></p> <p><a href="http://www.TheCreateRange.co.uk">www.TheCreateRange.co.uk</a></p>
---	---------------------------------------	--

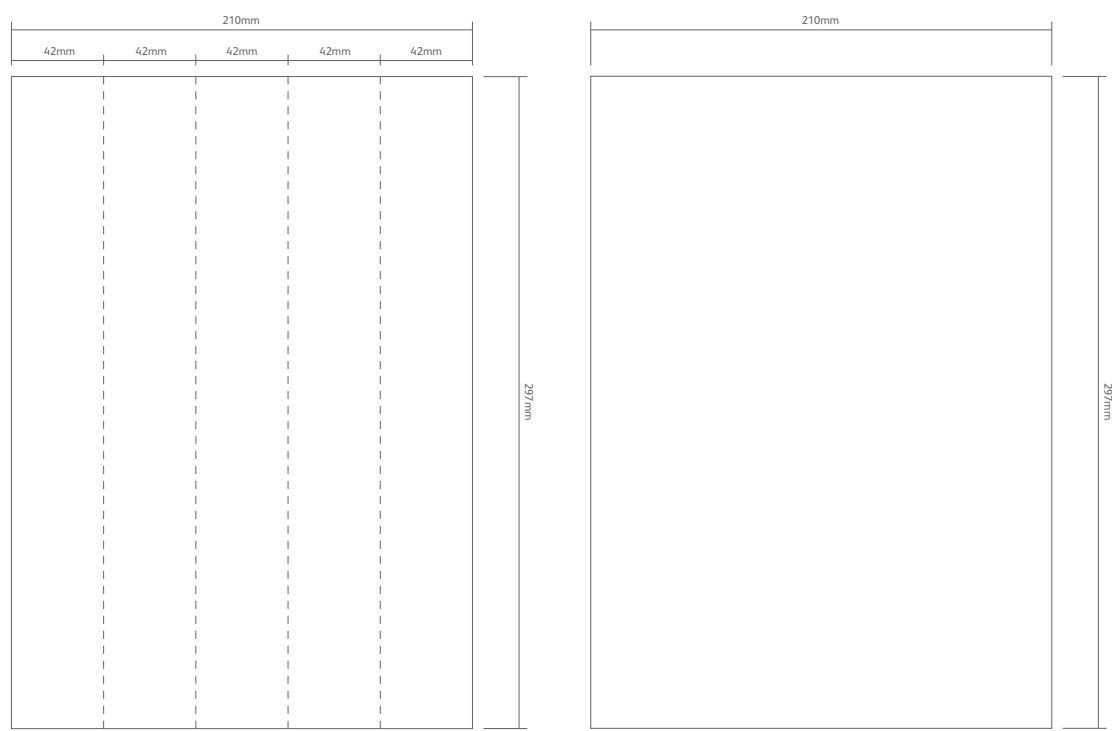



**antalis** <sup>TM</sup>

Just ask Antalis



PRODUCT DETAILS

Xerox Product Code <b>003R98884</b>	Antalis Product Code <b>67172</b>	Description <b>A4 RING BINDER 2 x 40mm D RING</b>
Supp Product Code <b>XR40</b>		Insert Sheet Size <b>210 x 297mm</b>
Supp Design No. <b>D4391</b>		Insert Paper <b>160gsm COLOUR IMPRESSIONS</b>
Size <b>268(w) x 310 (h) x 50(d)mm</b>		Items Per Box: <b>x25 BINDERS</b> <b>x32 SHEETS</b> <b>(26 front inserts / 30 spine inserts)</b>
Cover Material <b>1.2mm FROSTED CLEAR PP</b>		

PACKAGING DETAILS

Outer Case Design No. <b>D5721</b>	I.D. <b>455x 325 x 322mm</b>
Style <b>0201 GLUED</b>	O.D. <b>471 x 341 x 354mm</b>
Material <b>150KT BC FLUTE</b>	Case Weight <b>7.4Kg</b>

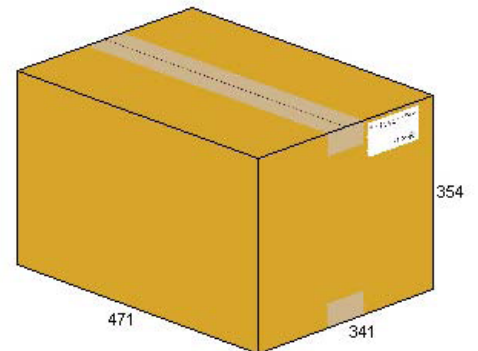

PALLETISATION DETAILS

UK Pallet 1200 x 1000mm
-------------------------

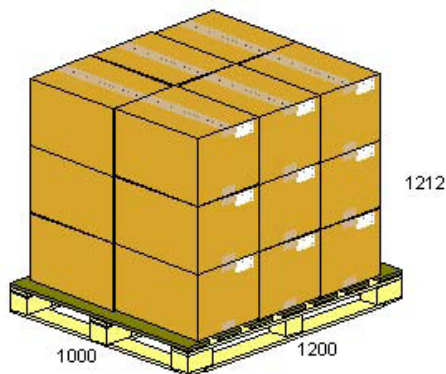

CASE LABELLING DETAILS

**xerox** 

Create Range  
A4 RING BINDER 2 x 40mm D RING

**x25**

**x32 sheets**  
(26 front inserts  
30 spine inserts)



5 01753 98884

7.4Kg  
MADE IN EU

# 003R98884

Cases / Layer	Layers	Total Cases
<b>6</b>	<b>3</b>	<b>18</b>
Items / Load		
<b>450 BINDERS</b>		
Load Weight (inc pallet)		
<b>158Kg</b>		

<p><b>Description</b></p> <p><b>A4 X FILE RING BINDER 4 x 25mm D RING</b></p>	<p><b>This Box Contains</b></p> <p><b>x20 BINDERS</b></p> <p><b>x30 SHEETS</b></p> <p><b>(26 front inserts / 24 spine inserts)</b></p>
	<p><b>Cover Material</b></p> <p><b>Polypropylene</b></p>  <p><b>100% Recyclable</b></p>
	<p><b>Size</b></p> <p><b>295(w) x 330(h) x 40(d)mm</b></p>

## Insert Sheet & Template

<p><b>Insert Sheet</b></p> <p>160gsm COLOUR IMPRESSIONS</p>	<p><b>Size</b></p> <p>210 x 297mm</p>	<p><b>Download template at</b></p> <p><a href="http://www.TheCreateRange.co.uk">www.TheCreateRange.co.uk</a></p>
---	---------------------------------------	--

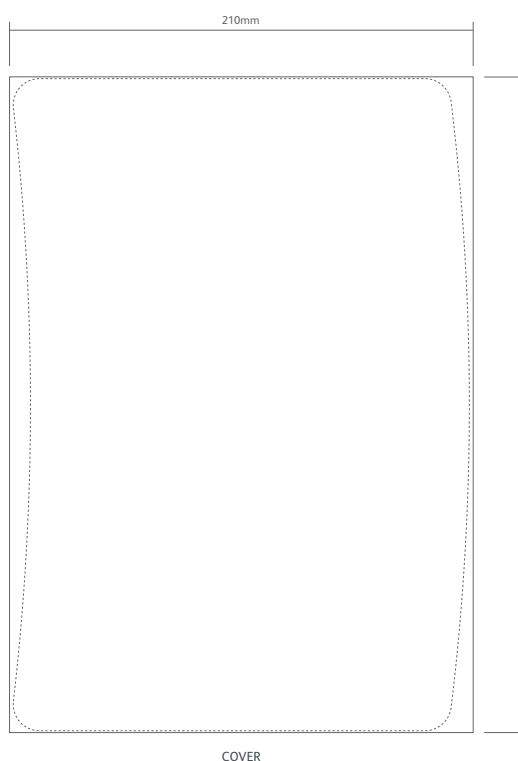
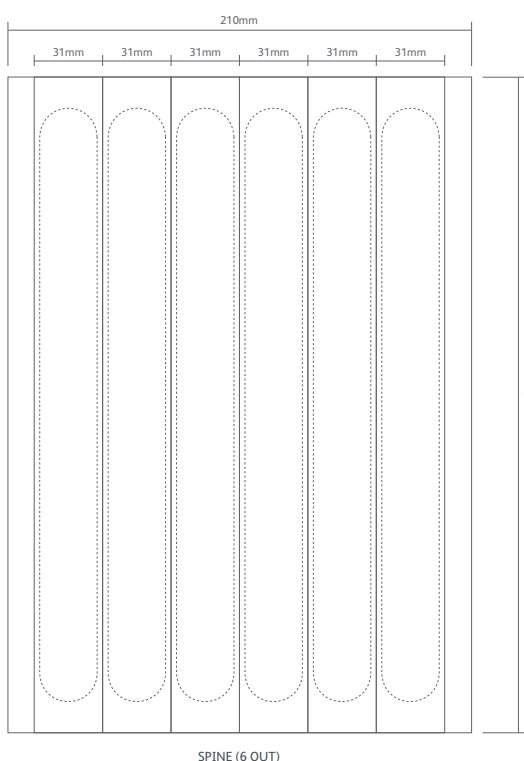

PRODUCT DETAILS

Xerox Product Code <b>003R98887</b>	Antalis Product Code <b>67169</b>	Description <b>A4 X FILE RING BINDER 4 x 25mm D RING</b>
Supp Product Code <b>XXF</b>	 <p>A white A4 file ring binder with a clear front cover showing a group of people. Dimensions are labeled: d (depth), w (width), and h (height).</p>	Insert Sheet Size <b>210 x 297mm</b>
Supp Design No. <b>D5685</b>		Insert Paper <b>160gsm COLOUR IMPRESSIONS</b>
Size <b>295(w) x 330(h) x 40(d)mm</b>		Items Per Box: <b>x20 BINDERS</b> <b>x30 SHEETS</b> <b>(26 front inserts / 24 spine inserts)</b>
Cover Material <b>WHITE PP</b>		

PACKAGING DETAILS

Outer Case Design No. <b>D5719</b>	I.D. <b>550 x 305 x 333mm</b>
Style <b>0201 GLUED</b>	O.D. <b>566 x 321 x 365mm</b>
Material <b>150KT BC FLUTE</b>	Case Weight <b>11.8Kg</b>

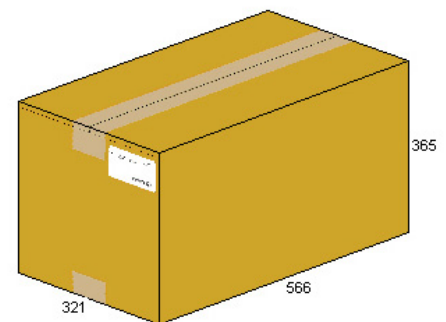

PALLETISATION DETAILS

UK Pallet 1200 x 1000mm

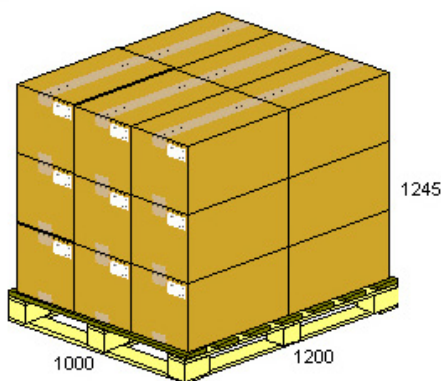

Cases / Layer	Layers	Total Cases
<b>6</b>	<b>3</b>	<b>18</b>

Items / Load  
**360 BINDERS**

Load Weight (inc pallet)  
**237Kg**

CASE LABELLING DETAILS

**xerox** 

Create Range  
A4 X FILE RING BINDER 4 x 25mm D RING

**x20**

**x30 sheets**  
(26 front inserts  
24 spine inserts)



5 01753 98887

003R98887

11.8Kg  
MADE IN EU



**Description**  
**A4 TUFF BINDER A4 POCKET 4 x 25mm D RING**

**This Box Contains**  
**x25 BINDERS**  
**x28 INSERTS**



**Cover Material**  
**88% Recycled Polypropylene**  
  
**100% Recyclable**

**Size**  
**259(w) x 318(h) x 39(d)mm**



## Insert Sheet & Template

**Insert Sheet**  
 160gsm COLOUR IMPRESSIONS

**Size**  
 210 x 297mm

**Download template at**  
[www.TheCreateRange.co.uk](http://www.TheCreateRange.co.uk)

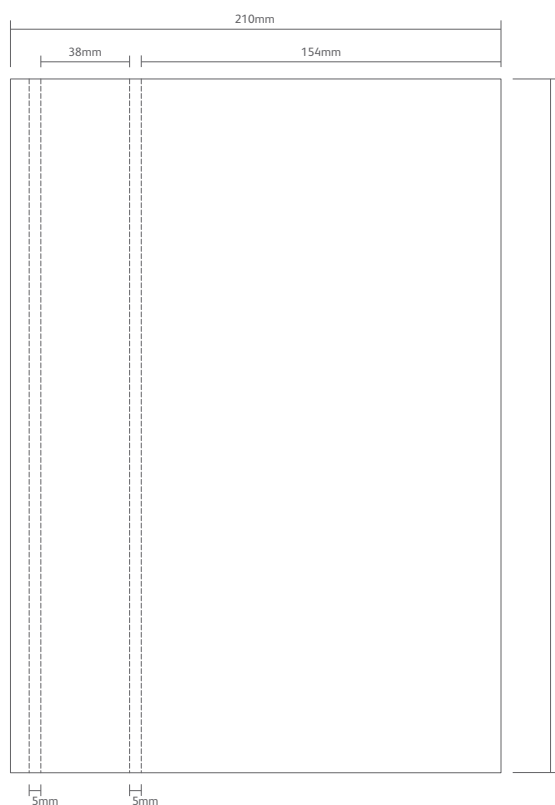

**antalis** <sup>TM</sup>  
 Just ask Antalis

**xerox** <sup>®</sup>  
 Trademark Licensee

PRODUCT DETAILS

Xerox Product Code <b>003R98886</b>	Antalis Product Code <b>67176</b>	Description <b>A4 TUFF BINDER A4 POCKET 4 x 25mm D RING</b>
Supp Product Code <b>XTFA4</b>		Insert Sheet Size <b>210 x 297mm</b>
Supp Design No. <b>D4715</b>		Insert Paper <b>160gsm COLOUR IMPRESSIONS</b>
Size <b>259(w) x 318(h) x 39(d)mm</b>		Items Per Box: <b>x25 BINDERS x28 INSERTS</b>
Cover Material <b>2.5mm 88% RECYCLED PP</b>		

PACKAGING DETAILS

Outer Case Design No. <b>D5721</b>	I.D. <b>455x 325 x 322mm</b>
Style <b>0201 GLUED</b>	O.D. <b>471 x 341 x 354mm</b>
Material <b>150KT BC FLUTE</b>	Case Weight <b>11.5Kg</b>

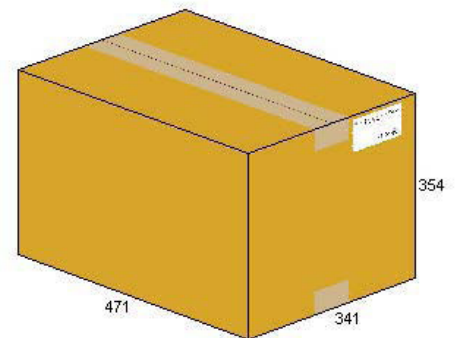

PALLETISATION DETAILS

UK Pallet 1200 x 1000mm

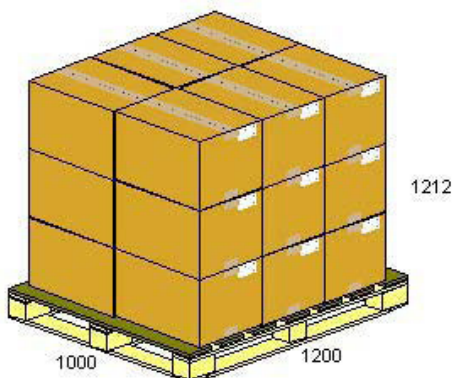

CASE LABELLING DETAILS

**xerox** 

Create Range  
A4 TUFF BINDER A4 POCKET 4 x 25mm D RING

x25

x28 inserts



003R98886

11.5Kg  
MADE IN EU

Cases / Layer	Layers	Total Cases
<b>6</b>	<b>3</b>	<b>18</b>
Items / Load		
<b>450 BINDERS</b>		
Load Weight (inc pallet)		
<b>232Kg</b>		

<p><b>Description</b>  <b>A4 TUFF BINDER FULL POCKET 4 x 25mm D RING</b></p>	<p><b>This Box Contains</b>  <b>x25 BINDERS</b>  <b>x28 INSERTS</b></p>
	<p><b>Cover Material</b>  <b>88% Recycled Polypropylene</b></p>  <p><b>100% Recyclable</b></p>
	<p><b>Size</b>  <b>259(w) x 318(h) x 39(d)mm</b></p>
	

## Insert Sheet & Template

<p><b>Insert Sheet</b>          160gsm COLOUR IMPRESSIONS</p>	<p><b>Size</b>          309 x 304mm</p>	<p><b>Download template at</b>  <a href="http://www.TheCreateRange.co.uk">www.TheCreateRange.co.uk</a></p>
---	---	--

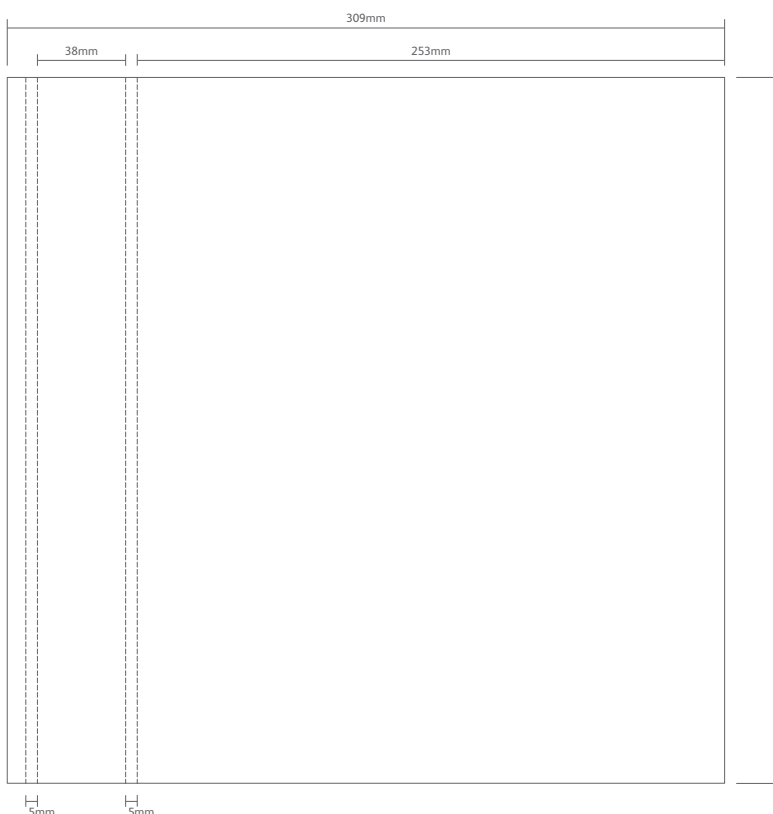

antalis <sup>TM</sup>  
 Just ask Antalis



PRODUCT DETAILS

Xerox Product Code <b>003R98882</b>	Antalis Product Code <b>67177</b>	Description <b>A4 TUFF BINDER FULL POCKET 4 x 25mm D RING</b>
Supp Product Code <b>XTFF</b>		Insert Sheet Size <b>309 x 304mm</b>
Supp Design No. <b>D5220</b>		Insert Paper <b>160gsm COLOUR IMPRESSIONS</b>
Size <b>259(w) x 318(h) x 39(d)mm</b>		Items Per Box: <b>x25 BINDERS x28 INSERTS</b>
Cover Material <b>2.5mm 88% RECYCLED PP</b>		

PACKAGING DETAILS

Outer Case Design No. <b>D5721</b>	I.D. <b>455x 325 x 322mm</b>
Style <b>0201 GLUED</b>	O.D. <b>471 x 341 x 354mm</b>
Material <b>150KT BC FLUTE</b>	Case Weight <b>11.5Kg</b>

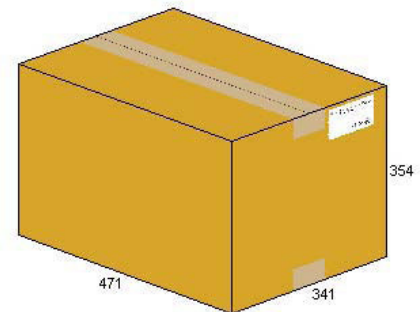

PALLETISATION DETAILS

UK Pallet 1200 x 1000mm

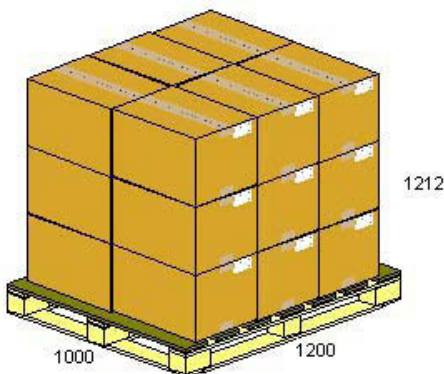

CASE LABELLING DETAILS

**xerox** 

Create Range  
A4 TUFF BINDER FULL POCKET 4 x 25mm D RING

x25

x28 inserts





5 01753 98882

11.5Kg  
MADE IN EU

# 003R98882

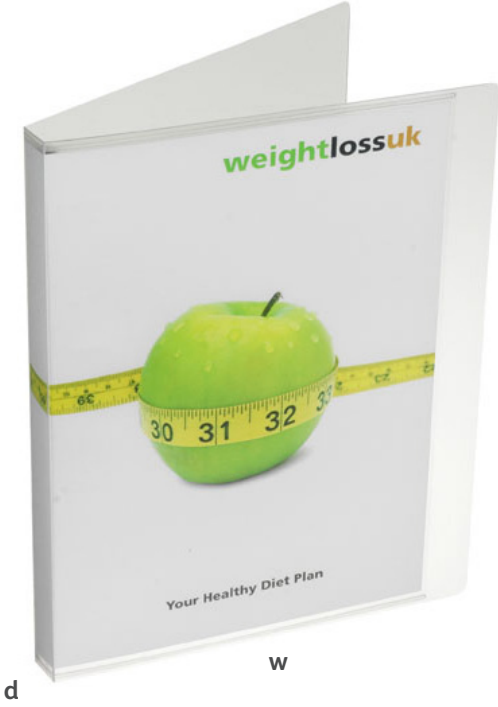
Cases / Layer	Layers	Total Cases
<b>6</b>	<b>3</b>	<b>18</b>
Items / Load		
<b>450 BINDERS</b>		
Load Weight (inc pallet)		
<b>232Kg</b>		

<p>Description</p> <p><b>A4 RING BINDER 4 x 11mm D RING</b></p>	<p>This Box Contains</p> <p><b>x50 BINDERS</b></p> <p><b>x55 INSERTS</b></p>
	<p>Cover Material</p> <p><b>Polypropylene</b></p>  <p><b>100% Recyclable</b></p>
<p>Size</p> <p><b>240(w) x 309(h) x 22(d)mm</b></p>	

## Insert Sheet & Template

<p>Insert Sheet</p> <p>160gsm COLOUR IMPRESSIONS</p>	<p>Size</p> <p>235x 297mm</p>	<p>Download template at</p> <p><a href="http://www.TheCreateRange.co.uk">www.TheCreateRange.co.uk</a></p>
--	-------------------------------	---

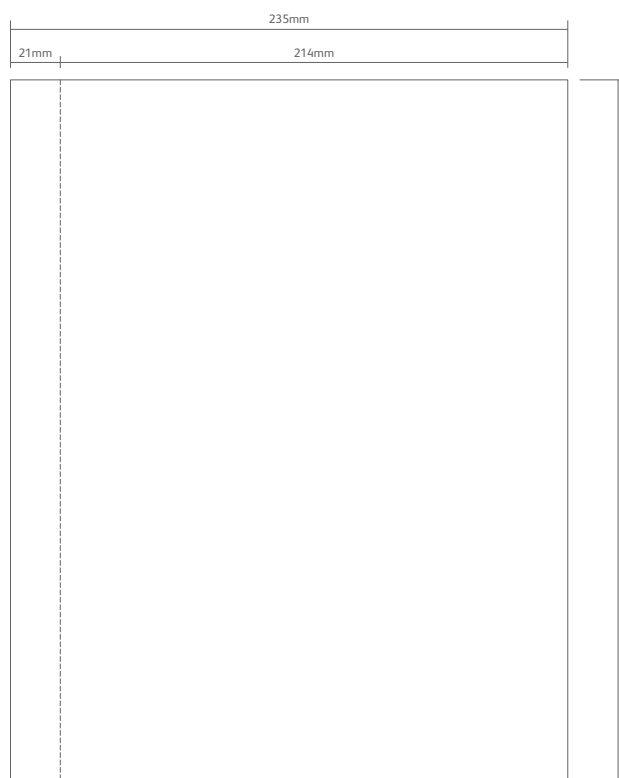

antalis <sup>TM</sup>  
Just ask Antalis

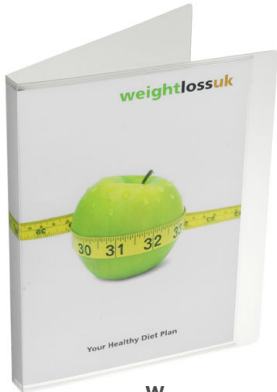

PRODUCT DETAILS

Xerox Product Code <b>003R98874</b>	Antalis Product Code <b>67173</b>	Description <b>A4 RING BINDER 4 x 11mm D RING</b>
Supp Product Code <b>XR11</b>		Insert Sheet Size <b>235 x 297mm</b>
Supp Design No. <b>D4351</b>		Insert Paper <b>160gsm COLOUR IMPRESSIONS</b>
Size <b>240(w) x 309(h) x 22(d)mm</b>		Items Per Box: <b>x50 BINDERS</b> <b>x55 INSERTS</b>
Cover Material <b>0.8mm ICE PP</b>		

PACKAGING DETAILS

Outer Case Design No. <b>D5723</b>	I.D. <b>335x 282 x 327mm</b>
Style <b>0201 GLUED</b>	O.D. <b>351 x 298 x 359mm</b>
Material <b>150KT BC FLUTE</b>	Case Weight <b>9.2Kg</b>

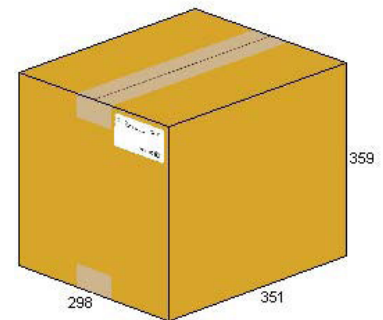

PALLETISATION DETAILS

UK Pallet 1200 x 1000mm

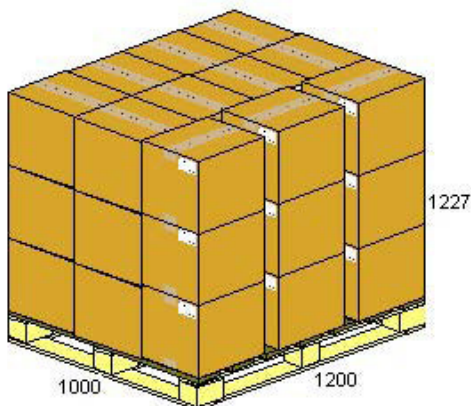

Cases / Layer <b>11</b>	Layers <b>3</b>	Total Cases <b>33</b>
Items / Load <b>1650 BINDERS</b>		
Load Weight (inc pallet) <b>329Kg</b>		

CASE LABELLING DETAILS

**xerox** 

Create Range  
A4 RING BINDER 4 x 11mm D RING

x50

x55 inserts



5 01753 98874

003R98874

9.2Kg  
MADE IN EU

<p>Description</p>	<p><b>A4 BINDER 4 x 25mm D RING</b></p>	<p>This Box Contains  <b>x50 BINDERS</b>  <b>x55 INSERTS</b></p>
		<p>Cover Material  <b>Polypropylene</b>    <b>100% Recyclable</b></p>
		<p>Size  <b>262(w) x 309(h) x 40(d)mm</b></p>

## Insert Sheet & Template

<p>Insert Sheet          160gsm COLOUR IMPRESSIONS</p>	<p>Size          297x 297mm</p>	<p>Download template at  <a href="http://www.TheCreateRange.co.uk">www.TheCreateRange.co.uk</a></p>
--	-------------------------------------	---

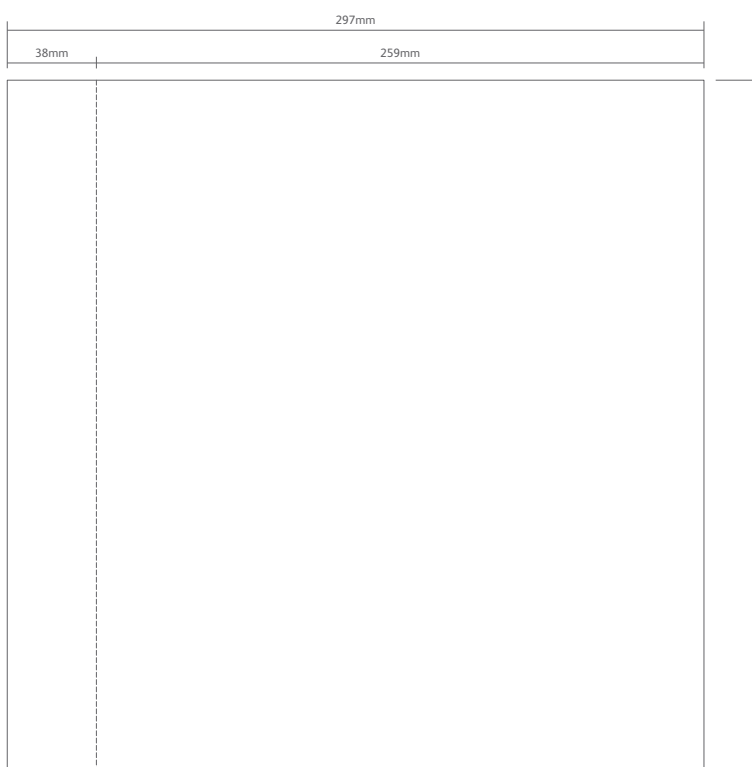

antalis <sup>TM</sup>  
 Just ask Antalis



PRODUCT DETAILS

Xerox Product Code <b>003R98875</b>	Antalis Product Code <b>67174</b>	Description <b>A4 BINDER 4 x 25mm D RING</b>
Supp Product Code <b>XR25</b>		Insert Sheet Size <b>297x 297mm</b>
Supp Design No. <b>D5344</b>		Insert Paper <b>160gsm COLOUR IMPRESSIONS</b>
Size <b>262(w) x 309(h) x 40(d)mm</b>		Items Per Box: <b>x50 BINDERS x55 INSERTS</b>
Cover Material <b>0.8mm ICE PP</b>		

PACKAGING DETAILS

Outer Case Design No. <b>D5721</b>	I.D. <b>455x 325 x 322mm</b>
Style <b>0201 GLUED</b>	O.D. <b>471 x 341 x 354mm</b>
Material <b>150KT BC FLUTE</b>	Case Weight <b>11.5Kg</b>

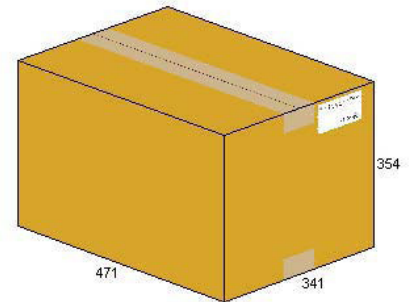

PALLETISATION DETAILS

UK Pallet 1200 x 1000mm

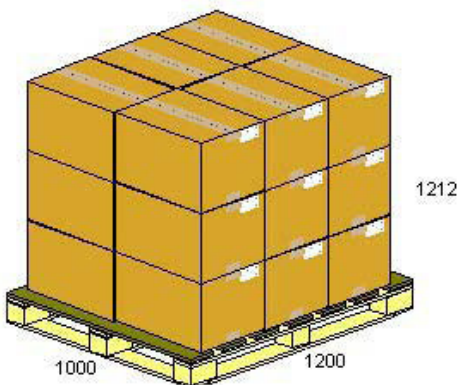

Cases / Layer <b>6</b>	Layers <b>3</b>	Total Cases <b>18</b>
Items / Load <b>900 BINDERS</b>		
Load Weight (inc pallet) <b>232Kg</b>		

CASE LABELLING DETAILS

**xerox** 

Create Range  
A4 BINDER 4 x 25mm D RING

x50

x55 inserts



003R98875

11.5Kg  
MADE IN EU



<b>Description</b> <b>A5 BINDER 2 x 35mm D RING</b>	<b>This Box Contains</b> <b>x50 BINDERS</b> <b>x55 INSERTS</b>
 <p><b>w</b> <b>h</b> <b>d</b></p>	<b>Cover Material</b> <b>Polypropylene</b>  <b>100% Recyclable</b>
	<b>Size</b> <b>203(w) x 225(h) x 51(d)mm</b>

## Insert Sheet & Template

<b>Insert Sheet</b> <b>160gsm COLOUR IMPRESSIONS</b>	<b>Size</b> <b>247 x 210mm</b>	<b>Download template at</b> <a href="http://www.TheCreateRange.co.uk">www.TheCreateRange.co.uk</a>
---	-----------------------------------	---



PRODUCT DETAILS

Xerox Product Code <b>003R98885</b>	Antalis Product Code <b>67180</b>	Description <b>A5 BINDER 2 x 35mm D RING</b>
Supp Product Code <b>XR35</b>		Insert Sheet Size <b>247 x 210mm</b>
Supp Design No. <b>D4570</b>		Insert Paper <b>160gsm COLOUR IMPRESSIONS</b>
Size <b>203(w) x 225(h) x 51(d)mm</b>		Items Per Box: <b>x50 BINDERS x55 INSERTS</b>
Cover Material <b>0.8mm ICE PP</b>		

PACKAGING DETAILS

Outer Case Design No. <b>D5721</b>	I.D. <b>455x 325 x 322mm</b>
Style <b>0201 GLUED</b>	O.D. <b>471 x 341 x 354mm</b>
Material <b>150KT BC FLUTE</b>	Case Weight <b>7.1Kg</b>

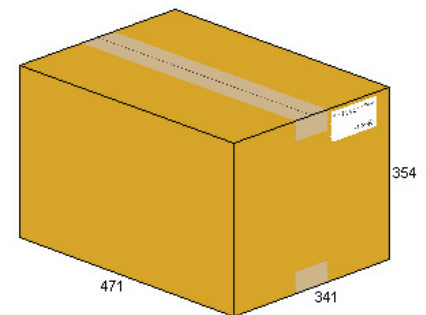

PALLETISATION DETAILS

UK Pallet 1200 x 1000mm

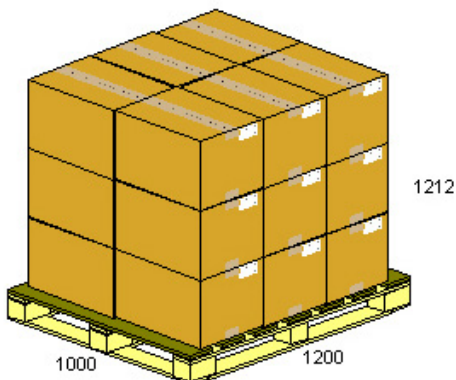

Cases / Layer <b>6</b>	Layers <b>3</b>	Total Cases <b>18</b>
Items / Load <b>900 BINDERS</b>		
Load Weight (inc pallet) <b>153Kg</b>		

CASE LABELLING DETAILS



Create Range  
A5 BINDER 2 x 35mm D RING

x50

x55 inserts



5 01753 98885

7.1Kg  
MADE IN EU

# 003R98885

<p>Description</p> <p><b>BOUTIQUE BAG LARGE</b></p>	<p>This Box Contains</p> <p><b>x50 BAGS</b> <b>x55 INSERTS</b></p>
	<p>Cover Material</p> <p><b>Polypropylene</b></p>  <p><b>100% Recyclable</b></p>
	<p>Size</p> <p><b>320(w) x 400(h) x 130(d)mm</b></p>

## Insert Sheet & Template

<p>Insert Sheet</p> <p>250gsm COLOUR IMPRESSIONS</p>	<p>Size</p> <p>318 x 428mm</p>	<p>Download template at</p> <p><a href="http://www.TheCreateRange.co.uk">www.TheCreateRange.co.uk</a></p>
--	--------------------------------	---

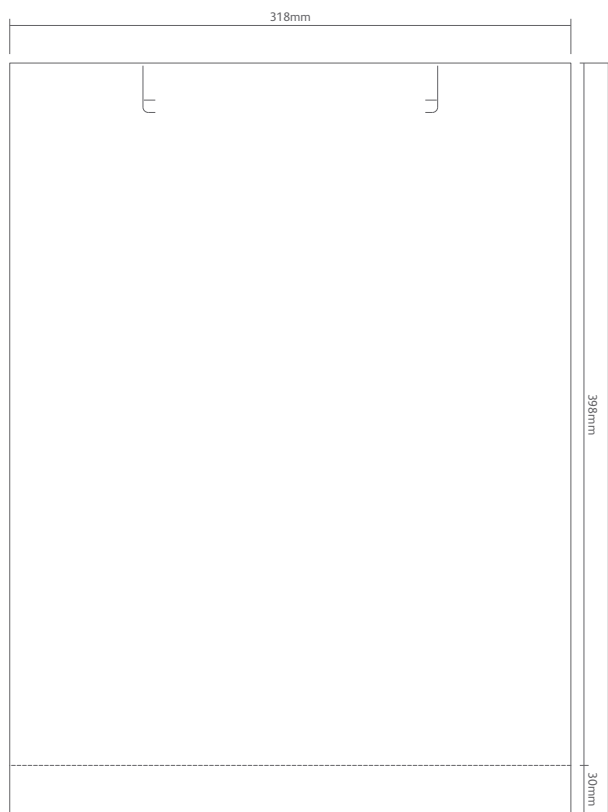

antalis <sup>TM</sup>  
Just ask Antalis



<p>Description</p> <p><b>BOUTIQUE BAG LARGE INSERTS</b></p>	<p>This Pack Contains</p> <p><b>x55 INSERTS</b></p>
	<p>Material</p> <p>250gsm COLOUR IMPRESSIONS</p> <p><b>100% Recyclable</b></p>
	<p>Size</p> <p><b>320(w) x 400(h) x 130(d)mm</b></p>

## Insert Sheet & Template

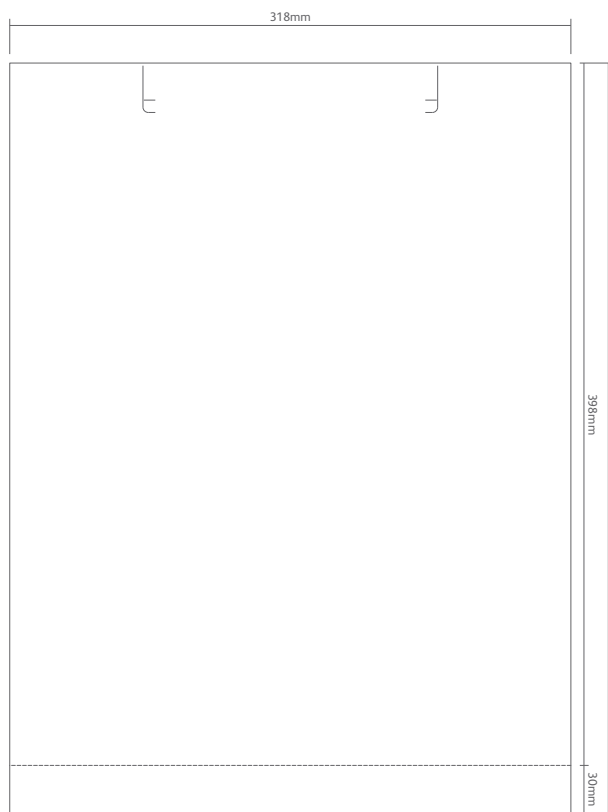

<p>Insert Sheet</p> <p>250gsm COLOUR IMPRESSIONS</p>	<p>Size</p> <p>318 x 428mm</p>	<p>Download template at</p> <p><a href="http://www.xerox.co.uk/printer-supplies/printing-templates">http://www.xerox.co.uk/printer-supplies/printing-templates</a></p>
--	--------------------------------	--



antalis <sup>TM</sup>  
Just ask Antalis



PRODUCT DETAILS

Xerox Product Code <b>003R98797</b>	Antalis Product Code <b>83410</b>	Description <b>BOUTIQUE BAG LARGE</b>
Supp Product Code <b>XLB</b>		Insert Sheet Size <b>428 x 318mm</b>
Supp Design No. <b>D5300</b>		Insert Paper <b>250gsm COLOUR IMPRESSIONS</b>
Size <b>320(w) x 400(h) x 130(d)mm</b>		Items Per Box: <b>x50 BAGS x55 INSERTS</b>
Cover Material <b>0.180mm FROSTED PP</b>		

PACKAGING DETAILS

Outer Case Design No. <b>D5143</b>	I.D. <b>490 x 326 x 170mm</b>
Style <b>0201 GLUED</b>	O.D. <b>506 x 342 x 202mm</b>
Material <b>150KT BC FLUTE</b>	Case Weight <b>9.8Kg</b>

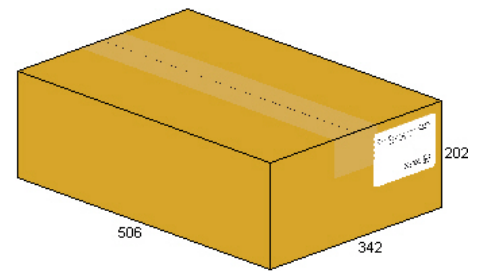

PALLETISATION DETAILS

UK Pallet 1200 x 1000mm
-------------------------

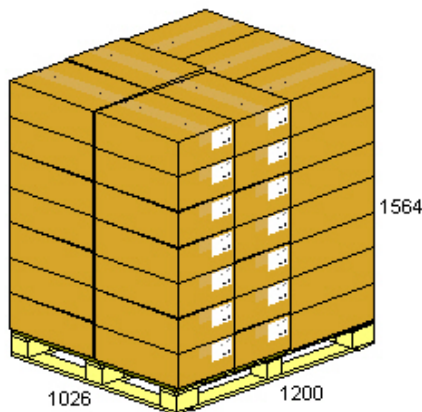

Cases / Layer	Layers	Total Cases
<b>7</b>	<b>7</b>	<b>49</b>
Items / Load		
<b>2,450 BAGS</b>		
Load Weight (inc pallet)		
<b>505Kg</b>		

CASE LABELLING DETAILS



<p>Description</p> <p><b>BOUTIQUE BAG SMALL</b></p>	<p>This Box Contains</p> <p><b>x50 BAGS</b></p> <p><b>x55 INSERTS</b></p>
	<p>Cover Material</p> <p><b>Polypropylene</b></p>  <p><b>100% Recyclable</b></p>
	<p>Size</p> <p><b>260(w) x 323(h) x 100(d)mm</b></p>

## Insert Sheet & Template

<p>Insert Sheet</p> <p>250gsm COLOUR IMPRESSIONS</p>	<p>Size</p> <p>259 x 418mm</p>	<p>Download template at</p> <p><a href="http://www.TheCreateRange.co.uk">www.TheCreateRange.co.uk</a></p>
--	--------------------------------	---

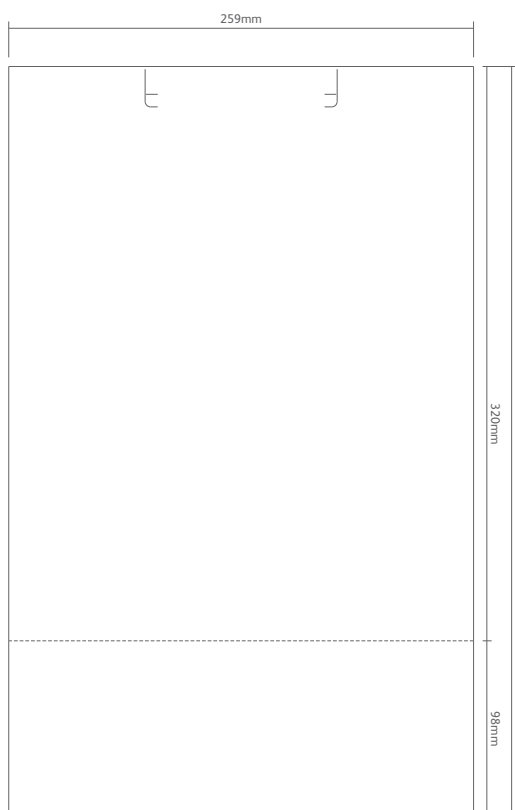

antalis <sup>TM</sup>  
Just ask Antalis



<p>Description</p> <p><b>BOUTIQUE BAG SMALL INSERTS</b></p>	<p>This Pack Contains</p> <p><b>x55 INSERTS</b></p>
	<p>Material</p> <p>250gsm COLOUR IMPRESSIONS</p> <p><b>100% Recyclable</b></p>
	<p>Size</p> <p><b>260(w) x 323(h) x 100(d)mm</b></p>

## Insert Sheet & Template

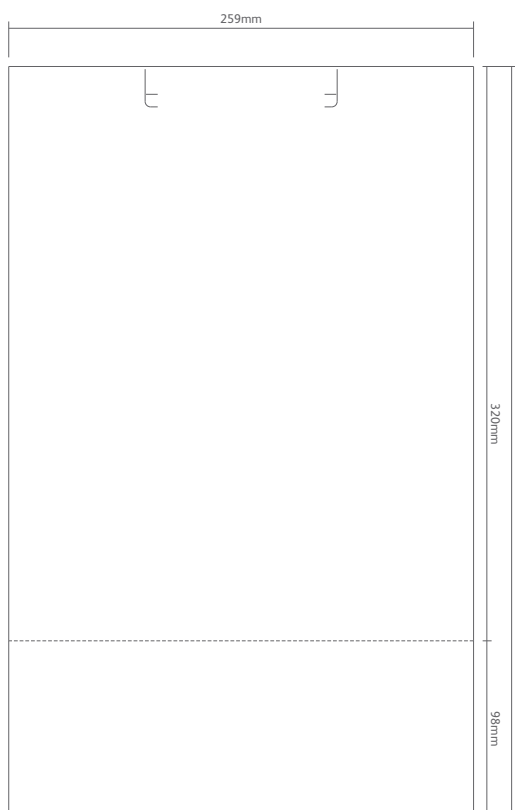

<p>Insert Sheet</p> <p>250gsm COLOUR IMPRESSIONS</p>	<p>Size</p> <p>259 x 418mm</p>	<p>Download template at</p> <p><a href="http://www.xerox.co.uk/printer-supplies/printing-templates">http://www.xerox.co.uk/printer-supplies/printing-templates</a></p>
--	--------------------------------	--



antalis <sup>TM</sup>  
Just ask Antalis



PRODUCT DETAILS

Xerox Product Code <b>003R98796</b>	Antalis Product Code <b>83412</b>	Description <b>BOUTIQUE BAG SMALL</b>
Supp Product Code <b>XSB</b>		Insert Sheet Size <b>259 x 418mm</b>
Supp Design No. <b>D4871</b>		Insert Paper <b>250gsm COLOUR IMPRESSIONS</b>
Size <b>260(w) x 323(h) x 100(d)mm</b>		Items Per Box: <b>x50 BAGS x55 INSERTS</b>
Cover Material <b>0.180 FROSTED PP</b>		

PACKAGING DETAILS

Outer Case Design No. <b>D5144</b>	I.D. <b>425 x 275 x 155mm</b>
Style <b>0201 GLUED</b>	O.D. <b>441 x 291 x 187mm</b>
Material <b>150KT BC FLUTE</b>	Case Weight <b>5.7Kg</b>

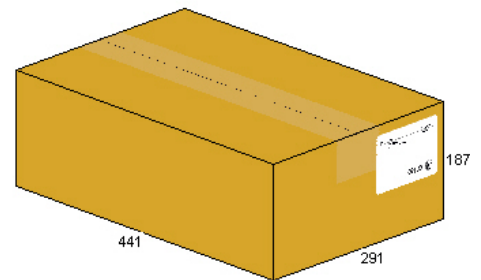

PALLETISATION DETAILS

UK Pallet 1200 x 1000mm
-------------------------

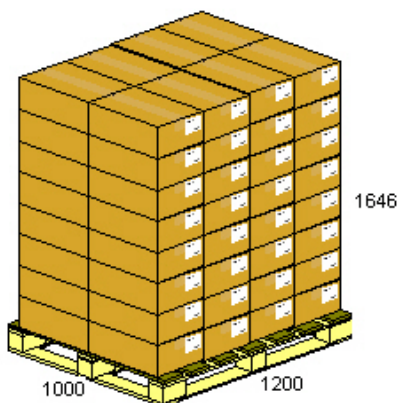

Cases / Layer <b>8</b>	Layers <b>8</b>	Total Cases <b>64</b>
Items / Load <b>3,200 BAGS</b>		
Load Weight (inc pallet) <b>372Kg</b>		

CASE LABELLING DETAILS



Create Range  
BOUTIQUE BAG SMALL

x50

x55 inserts



5 01753 98796

5.7Kg  
MADE IN EU

# 003R98796



<p>Description</p> <p><b>BOUTIQUE BAG EXTRA SMALL</b></p>	<p>This Box Contains</p> <p><b>x50 BAGS</b></p> <p><b>x55 INSERTS</b></p>
	<p>Cover Material</p> <p><b>Polypropylene</b></p>  <p><b>100% Recyclable</b></p>
	<p>Size</p> <p><b>190(w) x 236(h) x 70(d)mm</b></p>

## Insert Sheet & Template

<p>Insert Sheet</p> <p>250gsm COLOUR IMPRESSIONS</p>	<p>Size</p> <p>189 x 297mm</p>	<p>Download template at</p> <p><a href="http://www.TheCreateRange.co.uk">www.TheCreateRange.co.uk</a></p>
--	--------------------------------	---

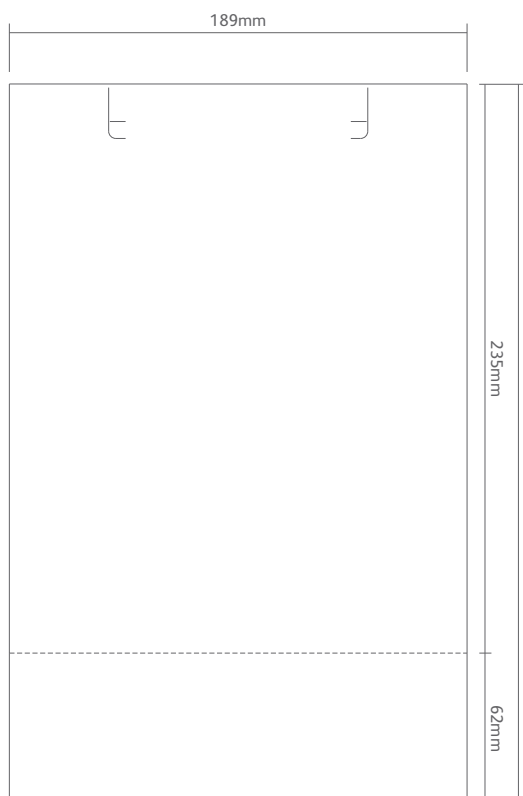

antalis <sup>TM</sup>  
Just ask Antalis



Description	<b>BOUTIQUE BAG EXTRA SMALL INSERTS</b>	This Pack Contains <b>x55 INSERTS</b>
-------------	---	--



Material
250gsm COLOUR IMPRESSIONS
<b>100% Recyclable</b>

Size
<b>190(w) x 236(h) x 70(d)mm</b>

## Insert Sheet & Template

Insert Sheet 250gsm COLOUR IMPRESSIONS	Size 189 x 297mm	Download template at <a href="http://www.xerox.co.uk/printer-supplies/printing-templates">http://www.xerox.co.uk/printer-supplies/printing-templates</a>
---	---------------------	---

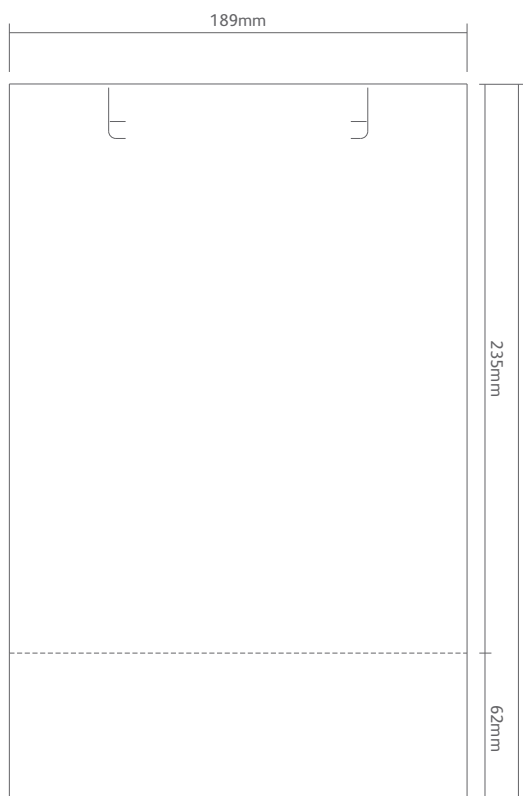

antalis <sup>TM</sup>  
Just ask Antalis



PRODUCT DETAILS

Xerox Product Code <b>003R98876</b>	Antalis Product Code <b>67183</b>	Description <b>BOUTIQUE BAG EXTRA SMALL</b>
Supp Product Code <b>XXSB</b>		Insert Sheet Size <b>189 x 297mm</b>
Supp Design No. <b>D5265</b>		Insert Paper <b>250gsm COLOUR IMPRESSIONS</b>
Size <b>190(w) x 236(h) x 70(d)mm</b>		Items Per Box: <b>x50 BAGS</b> <b>x55 INSERTS</b>
Cover Material <b>0.180 FROSTED PP</b>		

PACKAGING DETAILS

Outer Case Design No. <b>D5805</b>	I.D. <b>382 x 270 x 120mm</b>
Style <b>0201 GLUED</b>	O.D. <b>398 x 286 x 152mm</b>
Material <b>150KT BC FLUTE</b>	Case Weight <b>3.5Kg</b>

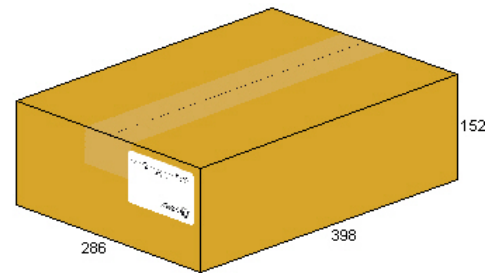

PALLETISATION DETAILS

UK Pallet 1200 x 1000mm

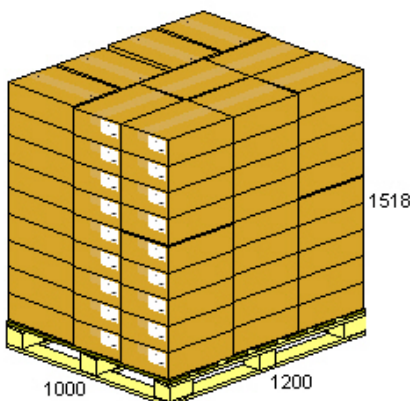

Cases / Layer	Layers	Total Cases
<b>10</b>	<b>9</b>	<b>90</b>
Items / Load <b>4,500 BAGS</b>		
Load Weight (inc pallet) <b>322Kg</b>		

CASE LABELLING DETAILS

**xerox** 

Create Range  
BOUTIQUE BAG EXTRA SMALL

x50

x55 inserts



5 01753 98876

003R98876

3.5Kg  
MADE IN EU

<p>Description</p> <p><b>BOTTLE GIFT BAG</b></p>	<p>This Box Contains</p> <p><b>x100 BAGS</b>  <b>x35 SHEETS</b>  <b>(105 inserts)</b></p>
	<p>Cover Material</p> <p><b>Polypropylene</b></p>  <p><b>100% Recyclable</b></p>
	<p>Size</p> <p><b>100(w) x 350(h) x 100(d)mm</b></p>

## Insert Sheet & Template

<p>Insert Sheet</p> <p>250gsm COLOUR IMPRESSIONS</p>	<p>Size</p> <p>420 x 297mm</p>	<p>Download template at</p> <p><a href="http://www.TheCreateRange.co.uk">www.TheCreateRange.co.uk</a></p>
--	--------------------------------	---

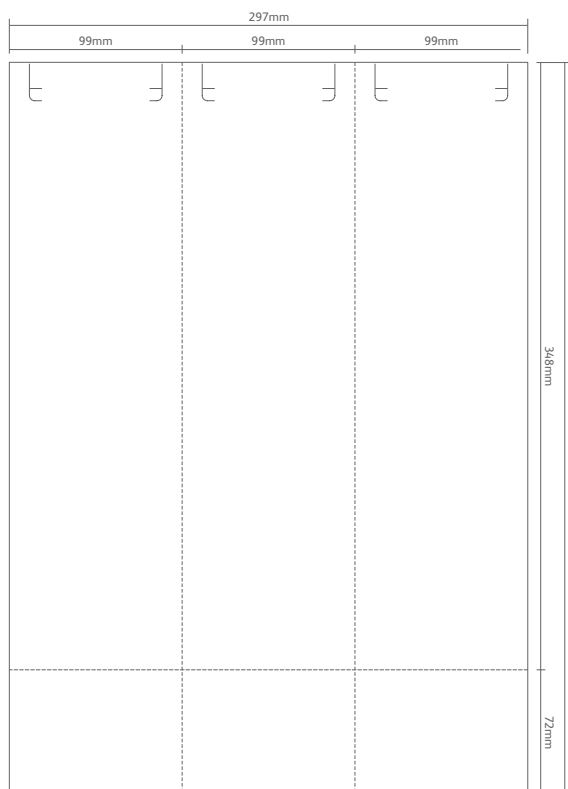

3 OUT PERFORATED A3 SHEET



antalis <sup>TM</sup>  
 Just ask Antalis



Description	<b>BOTTLE GIFT BAG INSERTS</b>
-------------	--------------------------------

This Box Contains <b>x35 SHEETS</b> (105 inserts)
---

Cover Material <b>250gsm COLOUR IMPRESSIONS</b>
<b>100% Recyclable</b>

Size <b>100(w) x 350(h) x 100(d)mm</b>
---



## Insert Sheet & Template

Insert Sheet 250gsm COLOUR IMPRESSIONS	Size 420 x 297mm	Download template at <a href="http://www.TheCreateRange.co.uk">www.TheCreateRange.co.uk</a>
---	---------------------	--

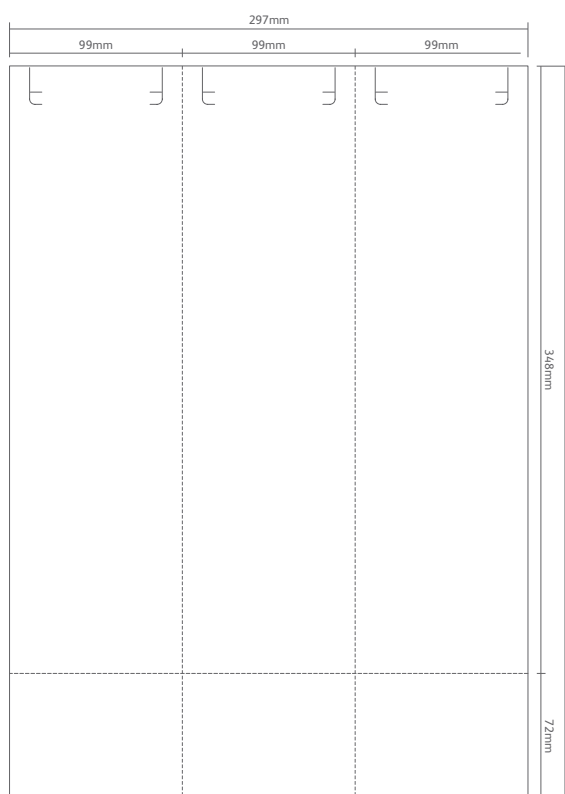

3 OUT PERFORATED A3 SHEET



antalis <sup>TM</sup>  
Just ask Antalis

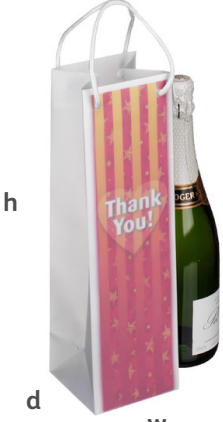

PRODUCT DETAILS

Xerox Product Code <b>003R95563</b>	Antalis Product Code <b>83715</b>	Description <b>BOTTLE GIFT BAG</b>
Supp Product Code <b>XBB</b>		Insert Sheet Size <b>420 x 297mm</b>
Supp Design No. <b>D5650</b>		Insert Paper <b>250gsm COLOUR IMPRESSIONS</b>
Size <b>100(w) x 350(h) x 100(d)mm</b>		Items Per Box: <b>x100 BAGS x35 SHEETS (105 inserts)</b>
Cover Material <b>0.180 FROSTED PP</b>		

PACKAGING DETAILS

Outer Case Design No. <b>D5976</b>	I.D. <b>533 x 426 x 125mm</b>
Style <b>0201 GLUED</b>	O.D. <b>549 x 442 x 157mm</b>
Material <b>150KT BC FLUTE</b>	Case Weight <b>6.4Kg</b>

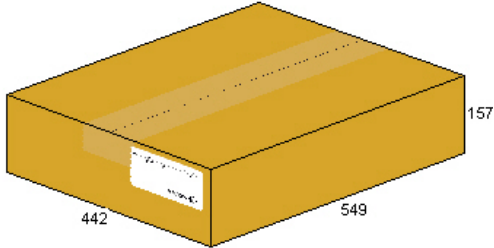

PALLETISATION DETAILS

UK Pallet 1200 x 1000mm

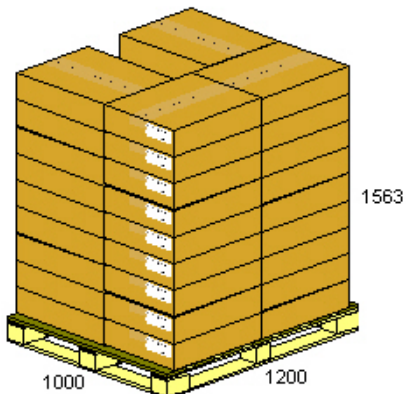

Cases / Layer <b>4</b>	Layers <b>9</b>	Total Cases <b>36</b>
Items / Load <b>3,600 BAGS</b>		
Load Weight (inc pallet) <b>255Kg</b>		

CASE LABELLING DETAILS



Create Range  
BOTTLE GIFT BAG

x100



x35 sheets  
(105 inserts)



5 01753 95563

6.4Kg  
MADE IN EU

# 003R95563

<p>Description</p> <p><b>NAME PLATE DISPLAY</b></p>	<p>This Box Contains</p> <p><b>x50 DISPLAYS</b></p> <p><b>x55 INSERTS</b></p>
	<p>Cover Material</p> <p><b>Polypropylene</b></p>  <p><b>100% Recyclable</b></p>
<p>Size</p> <p><b>213(w) x 78(h) x 78(d)mm</b></p>	

## Insert Sheet & Template

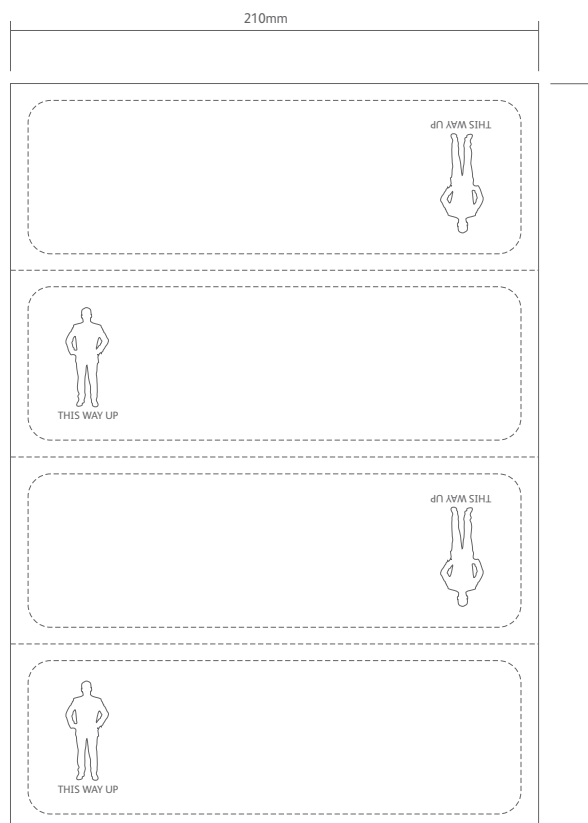

<p>Insert Sheet</p> <p>160gsm COLOUR IMPRESSIONS</p>	<p>Size</p> <p>210 x 297mm</p>	<p>Download template at</p> <p><a href="http://www.TheCreateRange.co.uk">www.TheCreateRange.co.uk</a></p>
--	--------------------------------	---



antalis <sup>TM</sup>  
Just ask Antalis



PRODUCT DETAILS

Xerox Product Code <b>003R93575</b>	Antalis Product Code <b>83647</b>	Description <b>NAME PLATE DISPLAY</b>
Supp Product Code <b>XNP</b>		Insert Sheet Size <b>210 x 297mm</b>
Supp Design No. <b>D5577</b>		Insert Paper <b>160gsm COLOUR IMPRESSIONS</b>
Size <b>213(w) x 78(h) x 78(d)mm</b>		Items Per Box: <b>x50 DISPLAYS</b> <b>x55 INSERTS</b>
Cover Material <b>0.8mm ICE PP</b>		

PACKAGING DETAILS

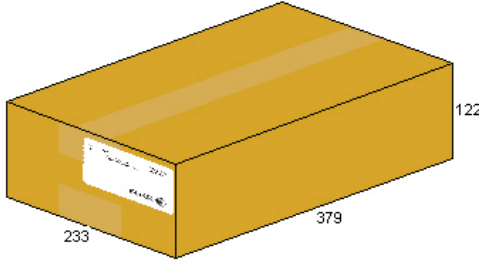
Outer Case Design No. <b>D5906</b>	I.D. <b>363 x 217 x 90mm</b>	
Style <b>0201 GLUED</b>	O.D. <b>379 x 233 x 122mm</b>	
Material <b>150KT BC FLUTE</b>	Case Weight <b>3Kg</b>	

PALLETISATION DETAILS

UK Pallet 1200 x 1000mm

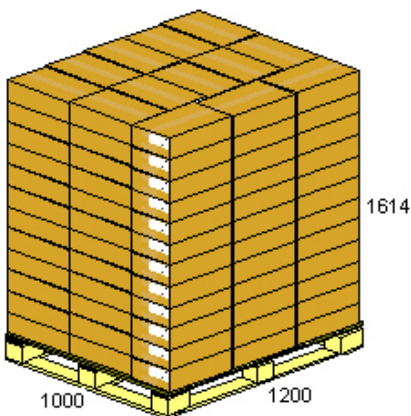

Cases / Layer <b>13</b>	Layers <b>12</b>	Total Cases <b>156</b>
Items / Load <b>7,800 DISPLAYS</b>		
Load Weight (inc pallet) <b>493Kg</b>		

CASE LABELLING DETAILS

**xerox** 

Create Range  
NAME PLATE DISPLAY

x50

x55 inserts



003R93575

3Kg  
MADE IN EU



<p>Description</p> <p><b>30cm RULER</b></p>	<p>This Box Contains</p> <p><b>x100 RULERS</b>  <b>x20 SHEETS</b>  <b>(120 inserts)</b></p>
<p>Cover Material</p> <p><b>Crystal Polystyrene</b></p>  <p><b>100% Recyclable</b></p>	
<p>Size</p> <p><b>318(L) x 53(W) x 5(H)mm</b></p>	



## Insert Sheet & Template

<p>Insert Sheet</p> <p>160gsm COLOUR IMPRESSIONS</p>	<p>Size</p> <p>210 x 297mm</p>	<p>Download template at</p> <p><a href="http://www.TheCreateRange.co.uk">www.TheCreateRange.co.uk</a></p>
--	--------------------------------	---

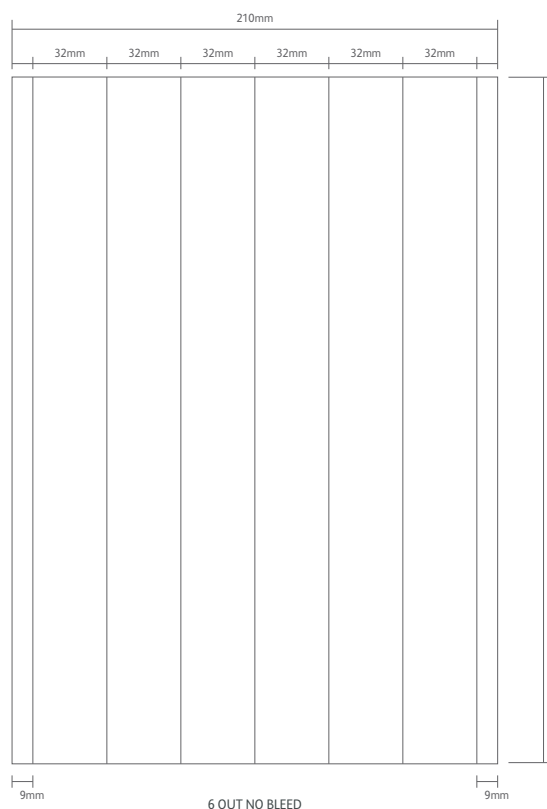



Xerox: 003R98878

Specification Sheet

Antalis: 83406

PRODUCT DETAILS

Xerox Product Code <b>003R98878</b>	Antalis Product Code <b>83406</b>	Description <b>30cm RULER</b>
Supp Product Code <b>XR30</b>		Insert Sheet Size <b>210 x 297mm</b>
Supp Design No. <b>D5690</b>		Insert Paper <b>160gsm COLOUR IMPRESSIONS</b>
Size <b>318(L) x 53(W) x 5(H)mm</b>		Items Per Box: <b>x100 RULERS x20 SHEETS (120 inserts)</b>
Cover Material <b>CRYSTAL POLYSTYRENE</b>		

PACKAGING DETAILS

Outer Case Design No. <b>D5895</b>	I.D. <b>325 x 325 x 133mm</b>
Style <b>0201 GLUED</b>	O.D. <b>341 x 341 x 165mm</b>
Material <b>150KT BC FLUTE</b>	Case Weight <b>7.3Kg</b>

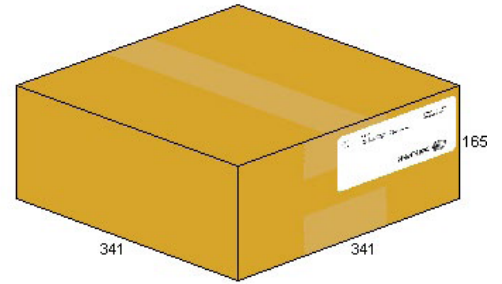

PALLETISATION DETAILS

UK Pallet 1200 x 1000mm

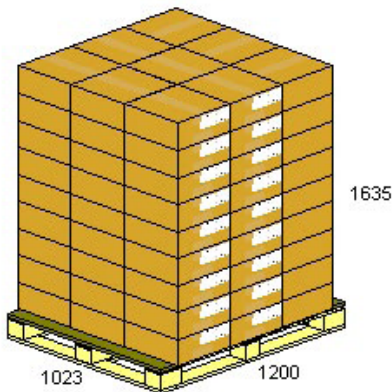

Cases / Layer	Layers	Total Cases
<b>9</b>	<b>9</b>	<b>81</b>
Items / Load <b>8,100 RULERS</b>		
Load Weight (inc pallet) <b>616Kg</b>		

CASE LABELLING DETAILS



Create Range  
30CM RULER

x100  
x20 sheets  
(120 inserts)



5 01753 98878

7.3Kg  
MADE IN EU

# 003R98878

Description	<b>SQUARE COASTER</b>
-------------	-----------------------

This Box Contains  
**x200 COASTERS**  
**x35 SHEETS**  
**(210 inserts)**

Cover Material  
**Crystal Polystyrene**  
  
**100% Recyclable**

Size  
**95(w) x 95(d) x 5(h)mm**



## Insert Sheet & Template

Insert Sheet 160gsm COLOUR IMPRESSIONS	Size 210 x 297mm	Download template at <a href="http://www.TheCreateRange.co.uk">www.TheCreateRange.co.uk</a>
---	---------------------	--

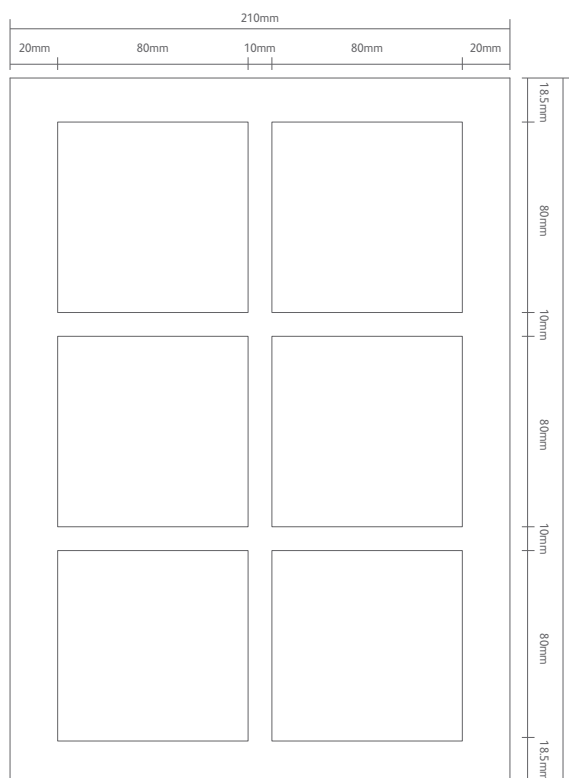



6 OUT



**antalis** <sup>TM</sup>  
 Just ask Antalis



PRODUCT DETAILS

Xerox Product Code <b>003R98877</b>	Antalis Product Code <b>67190</b>	Description <b>SQUARE COASTER</b>
Supp Product Code <b>XSC</b>		Insert Sheet Size <b>210 x 297mm</b>
Supp Design No. <b>D5689</b>		Insert Paper <b>160gsm COLOUR IMPRESSIONS</b>
Size <b>95(w) x 95(d) x 5(h)mm</b>		Items Per Box: <b>x200 COASTERS x35 SHEETS (210 inserts)</b>
Cover Material <b>CRYSTAL POLYSTYRENE</b>		

PACKAGING DETAILS

Outer Case Design No. <b>D5891</b>	I.D. <b>305 x 237 x 225mm</b>
Style <b>0201 GLUED</b>	O.D. <b>321 x 253 x 257mm</b>
Material <b>150KT BC FLUTE</b>	Case Weight <b>7.5Kg</b>

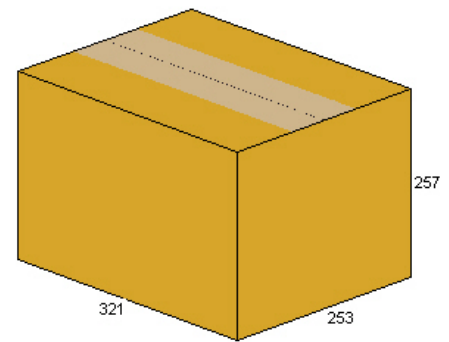

PALLETISATION DETAILS

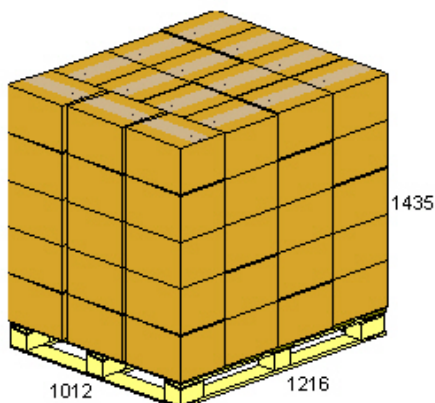

UK Pallet 1200 x 1000mm



Cases / Layer	Layers	Total Cases
<b>15</b>	<b>5</b>	<b>75</b>
Items / Load <b>15,000 RULERS</b>		
Load Weight (inc pallet) <b>587Kg</b>		

CASE LABELLING DETAILS



<p>Description</p> <p style="text-align: center;"><b>MOUSE MAT</b></p>	<p>This Box Contains</p> <p style="text-align: center;"><b>x50 MATS</b> <b>x55 INSERTS</b></p>
	<p>Cover Material</p> <p style="text-align: center;">PVC</p>  <p style="text-align: center;"><b>100% Recyclable</b></p>
	<p>Size</p> <p style="text-align: center;"><b>230(w) x 195(h) x 2(d)mm</b></p>

## Insert Sheet & Template

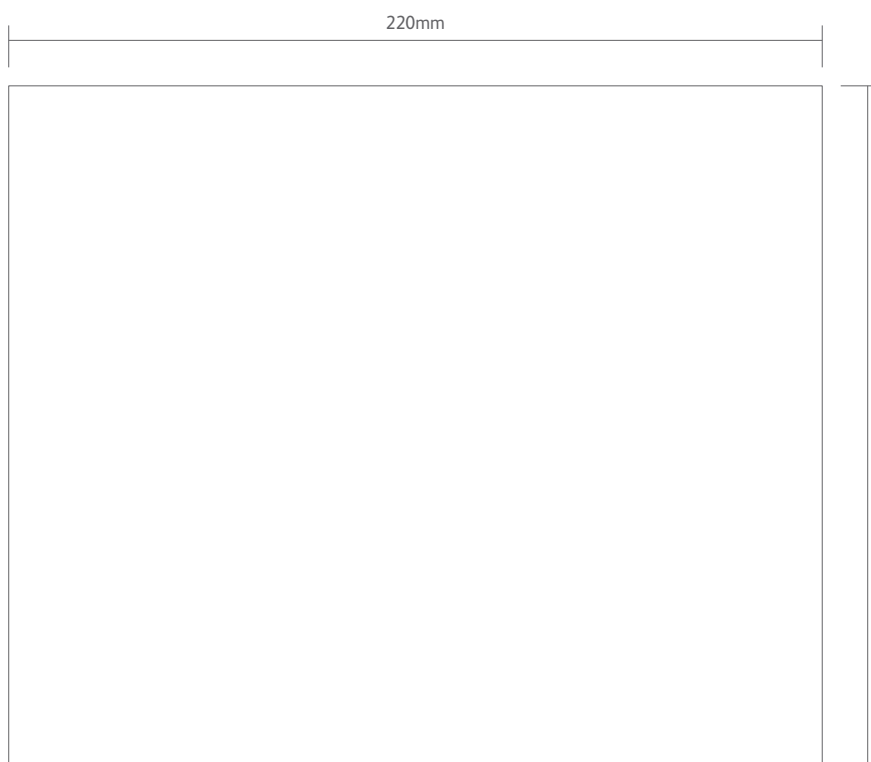

<p>Insert Sheet</p> <p>160gsm COLOUR IMPRESSIONS</p>	<p>Size</p> <p>220 x 185mm</p>	<p>Download template at</p> <p><a href="http://www.TheCreateRange.co.uk">www.TheCreateRange.co.uk</a></p>
--	--------------------------------	---



antalis <sup>TM</sup>  
Just ask Antalis



PRODUCT DETAILS

Xerox Product Code <b>003R98798</b>	Antalis Product Code <b>83536</b>	Description <b>MOUSE MAT</b>
Supp Product Code <b>XMM</b>		Insert Sheet Size <b>220 x 185mm</b>
Supp Design No. <b>D5688</b>		Insert Paper <b>160gsm COLOUR IMPRESSIONS</b>
Size <b>230(w) x 195(h) x 2(d)mm</b>		Items Per Box: <b>x50 MATS x55 INSERTS</b>
Cover Material <b>415mym MARK RESIST PVC</b>		

PACKAGING DETAILS

Outer Case Design No. <b>D5695</b>	I.D. <b>235 x 200 x 104mm</b>
Style <b>0201 GLUED</b>	O.D. <b>251 x 216 x 136mm</b>
Material <b>150KT BC FLUTE</b>	Case Weight <b>3.6Kg</b>



PALLETISATION DETAILS

UK Pallet 1200 x 1000mm
-------------------------

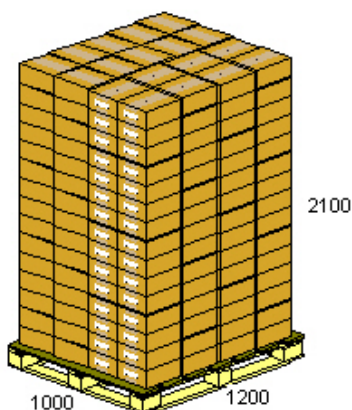

Cases / Layer	Layers	Total Cases
<b>18</b>	<b>15</b>	<b>270</b>
Items / Load <b>13,500 MATS</b>		
Load Weight (inc pallet) <b>986Kg</b>		

CASE LABELLING DETAILS



Create Range  
MOUSE MAT

x50



x55 inserts



5 01753 98798

3.6Kg  
MADE IN EU

# 003R98798

<p>Description</p> <p style="text-align: center;"><b>A3 COUNTER MAT</b></p>	<p>This Box Contains</p> <p style="text-align: center;"><b>x75 MATS</b> <b>x80 INSERTS</b></p>
	<p>Cover Material</p> <p style="text-align: center;"><b>PVC</b></p>  <p style="text-align: center;"><b>100% Recyclable</b></p>
	<p>Size</p> <p style="text-align: center;"><b>435(w) x 315(h) x 2(d)mm</b></p>

## Insert Sheet & Template

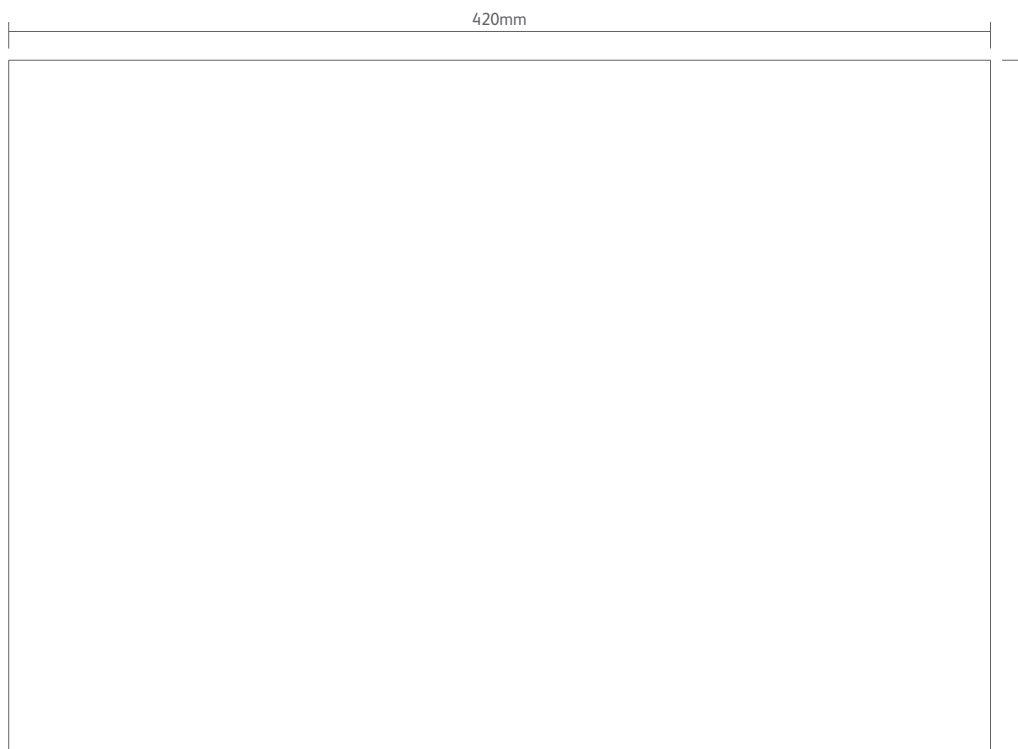

<p>Insert Sheet</p> <p>160gsm COLOUR IMPRESSIONS</p>	<p>Size</p> <p>420 x 297mm</p>	<p>Download template at</p> <p><a href="http://www.TheCreateRange.co.uk">www.TheCreateRange.co.uk</a></p>
--	--------------------------------	---



antalis <sup>TM</sup>  
Just ask Antalis



PRODUCT DETAILS

Xerox Product Code <b>003R98883</b>	Antalis Product Code <b>83407</b>	Description <b>A3 COUNTER MAT</b>
Supp Product Code <b>XM3</b>		Insert Sheet Size <b>420 x 297mm</b>
Supp Design No. <b>D5691</b>		Insert Paper <b>160gsm COLOUR IMPRESSIONS</b>
Size <b>435(w) x 315(h) x 2(d)mm</b>		Items Per Box: <b>x75 MATS x80 INSERTS</b>
Cover Material <b>415mym MARK RESIST PVC</b>		

PACKAGING DETAILS

Outer Case Design No. <b>D5751</b>	I.D. <b>442 x 322 x 142mm</b>
Style <b>0201 GLUED</b>	O.D. <b>458 x 338 x 174mm</b>
Material <b>150KT BC FLUTE</b>	Case Weight <b>16Kg</b>

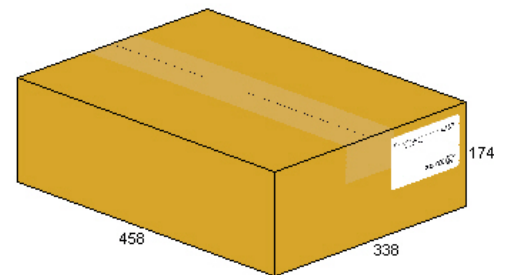

PALLETISATION DETAILS

UK Pallet 1200 x 1000mm

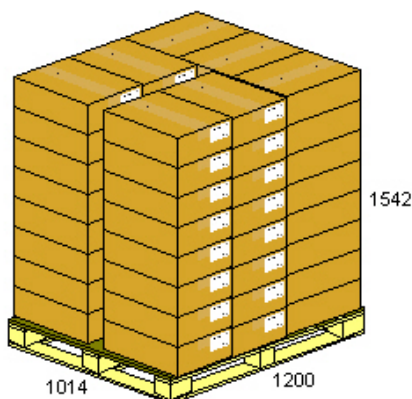

CASE LABELLING DETAILS

**xerox** 

Create Range  
A3 COUNTER MAT

x75

x80 inserts



003R98883

16Kg  
MADE IN EU

Cases / Layer	Layers	Total Cases
<b>7</b>	<b>8</b>	<b>56</b>
Items / Load		
<b>4,200 MATS</b>		
Load Weight (inc pallet)		
<b>921Kg</b>		



<p>Description</p> <p><b>A4 WINDOW DISPLAY</b></p>	<p>This Box Contains</p> <p><b>x10 DISPLAYS</b></p> <p><b>x15 INSERTS</b></p>
 <p>h</p> <p>d</p> <p>w</p>	<p>Cover Material</p> <p><b>PETG</b></p>  <p><b>PET</b></p> <p><b>100% Recyclable</b></p>
	<p>Size</p> <p><b>252(w) x 305(h) x 4(d)mm</b></p>

## Insert Sheet & Template

<p>Insert Sheet</p> <p>160gsm COLOUR IMPRESSIONS</p>	<p>Size</p> <p>210 x 297mm</p>	<p>Download template at</p> <p><a href="http://www.xerox.co.uk/printer-supplies/printing-templates">http://www.xerox.co.uk/printer-supplies/printing-templates</a></p>
--	--------------------------------	--

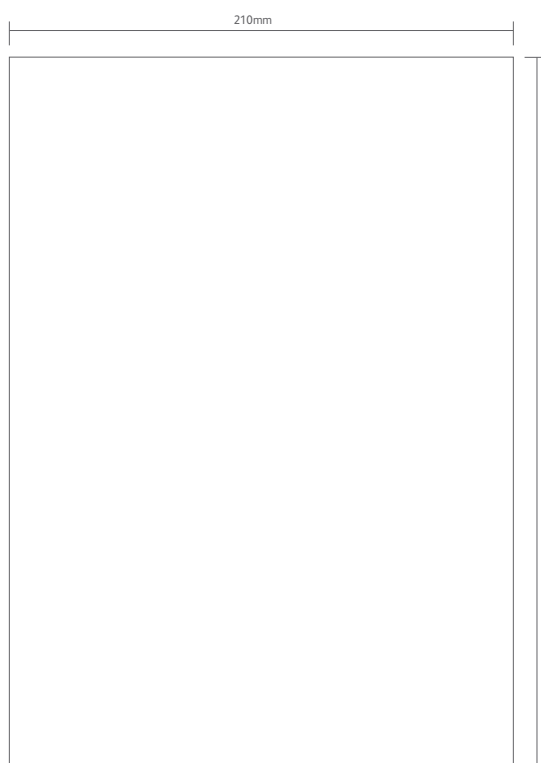

antalis <sup>TM</sup>

Just ask Antalis



PRODUCT DETAILS

Xerox Product Code <b>003R95783</b>	Antalis Product Code <b>67178</b>	Description <b>A4 WINDOW DISPLAY</b>
Supp Product Code <b>XWD</b>		Insert Sheet Size <b>210mm x 297mm</b>
Supp Design No. <b>D5856</b>		Insert Paper <b>160gsm COLOUR IMPRESSIONS</b>
Size <b>252(w) x 305(h) x 4(d)mm</b>		Items Per Box: <b>x10 DISPLAYS x15 INSERTS</b>
Cover Material <b>0.8mm CLEAR PETG</b>		

PACKAGING DETAILS

Outer Case Design No. <b>D6062</b>	I.D. <b>308 x 257 x 70mm</b>
Style <b>0201 GLUED</b>	O.D. <b>324 x 273 x 102mm</b>
Material <b>150KT BC FLUTE</b>	Case Weight <b>2Kg</b>

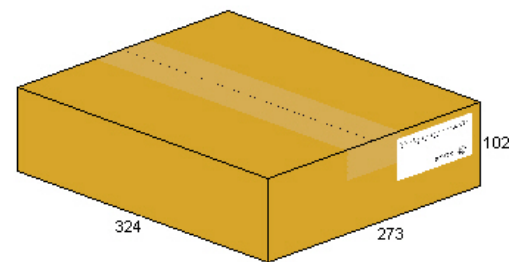

PALLETISATION DETAILS

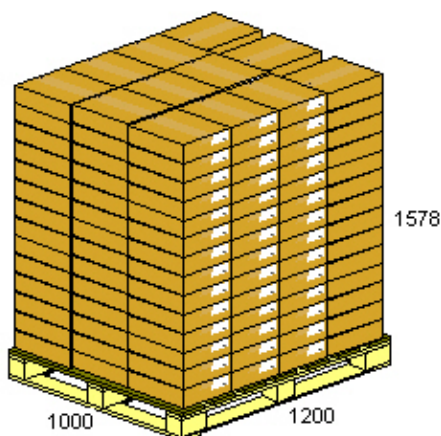

UK Pallet 1200 x 1000mm



Cases / Layer	Layers	Total Cases
<b>12</b>	<b>14</b>	<b>168</b>
Items / Load <b>1680 DISPLAYS</b>		
Load Weight (inc pallet) <b>361Kg</b>		

CASE LABELLING DETAILS



<p>Description</p> <p><b>A4 LEAFLET DISPENSER</b></p>	<p>This Box Contains</p> <p><b>x50 DISPENSERS</b>  <b>x30 SHEETS</b>  <b>(60 inserts)</b></p>
 <p>h</p> <p>d</p> <p>w</p>	<p>Cover Material</p> <p><b>Polypropylene</b></p>  <p><b>100% Recyclable</b></p>
<p>Size</p> <p><b>239(w) x 310(h) x 40(d)mm</b></p>	

## Insert Sheet & Template

<p>Insert Sheet</p> <p>160gsm COLOUR IMPRESSIONS</p>	<p>Size</p> <p>210 x 297mm</p>	<p>Download template at</p> <p><a href="http://www.TheCreateRange.co.uk">www.TheCreateRange.co.uk</a></p>
--	--------------------------------	---

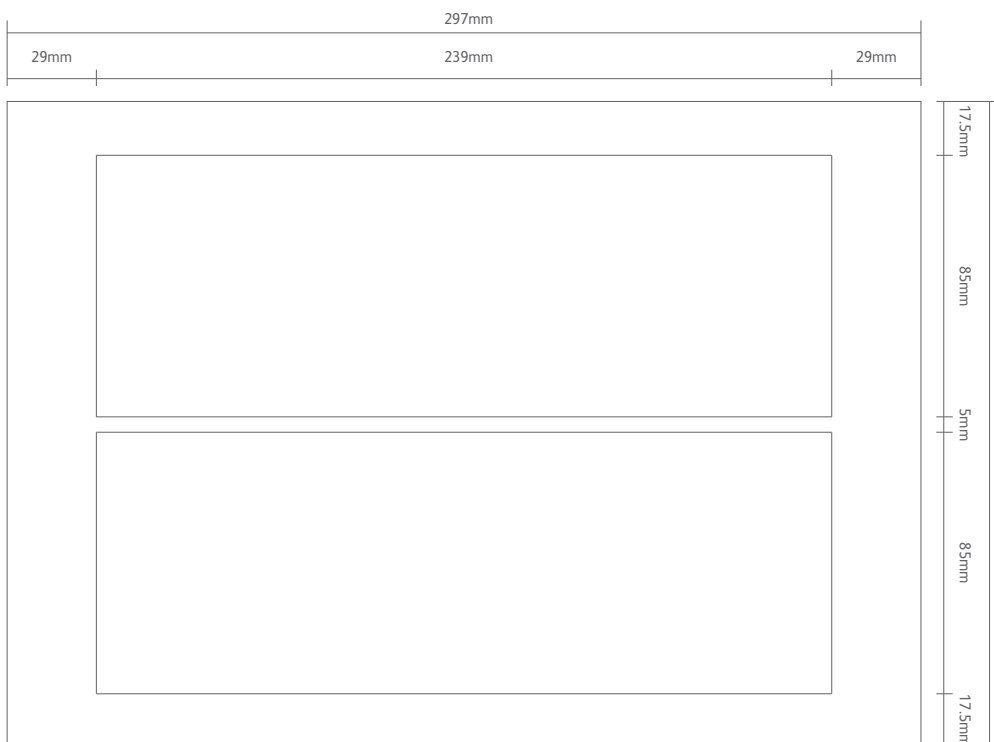



2 OUT



antalis <sup>TM</sup>  
Just ask Antalis



PRODUCT DETAILS

Xerox Product Code <b>003R98881</b>	Antalis Product Code <b>67175</b>	Description <b>A4 LEAFLET DISPENSER</b>
Supp Product Code <b>XLD</b>		Insert Sheet Size <b>210 x 297mm</b>
Supp Design No. <b>D4501</b>		Insert Paper <b>160gsm COLOUR IMPRESSIONS</b>
Size <b>239(w) x 310(h) x 40(d)mm</b>		Items Per Box: <b>x50 DISPENSERS x30 SHEETS (60 inserts)</b>
Cover Material <b>1.2mm FROSTED PP</b>		

PACKAGING DETAILS

Outer Case Design No. <b>D5783</b>	I.D. <b>447x 247 x 129mm</b>
Style <b>0201 GLUED</b>	O.D. <b>463 x 263 x 161mm</b>
Material <b>150KT BC FLUTE</b>	Case Weight <b>8.2Kg</b>

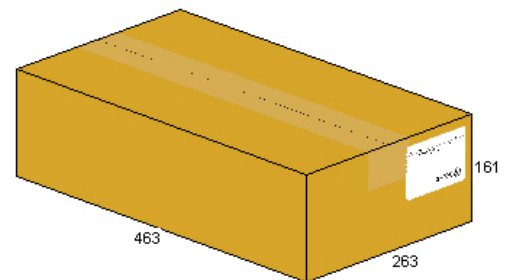

PALLETISATION DETAILS

UK Pallet 1200 x 1000mm
-------------------------

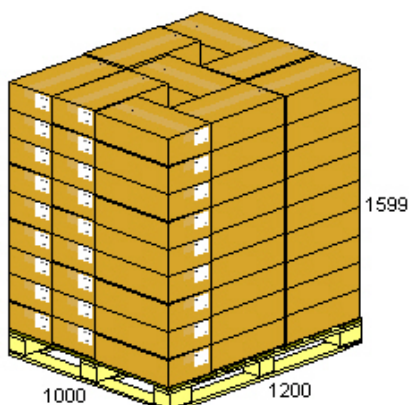

Cases / Layer	Layers	Total Cases
<b>9</b>	<b>9</b>	<b>81</b>
Items / Load <b>4,050 DISPENSERS</b>		
Load Weight (inc pallet) <b>689Kg</b>		

CASE LABELLING DETAILS

**xerox** 

Create Range  
A4 LEAFLET DISPENSER

**x50**  
**x30 sheets**  
**(60 inserts)**



5 01753 98881

003R98881

8.2Kg  
MADE IN EU

<p>Description</p> <p><b>FROSTED MAGAZINE FILE</b></p>	<p>This Box Contains</p> <p><b>x20 FILES</b> <b>x5 SHEETS</b> <b>(30 inserts)</b></p>
	<p>Cover Material</p> <p><b>Polypropylene</b></p>  <p><b>100% Recyclable</b></p>
	<p>Size</p> <p><b>104(w) x 325(h) x 257(d)mm</b></p> 

## Insert Sheet & Template

<p>Insert Sheet</p> <p>120gsm DRY PEEL</p>	<p>Size</p> <p>210 x 297mm</p>	<p>Download template at</p> <p><a href="http://www.TheCreateRange.co.uk">www.TheCreateRange.co.uk</a></p>
--	--------------------------------	---

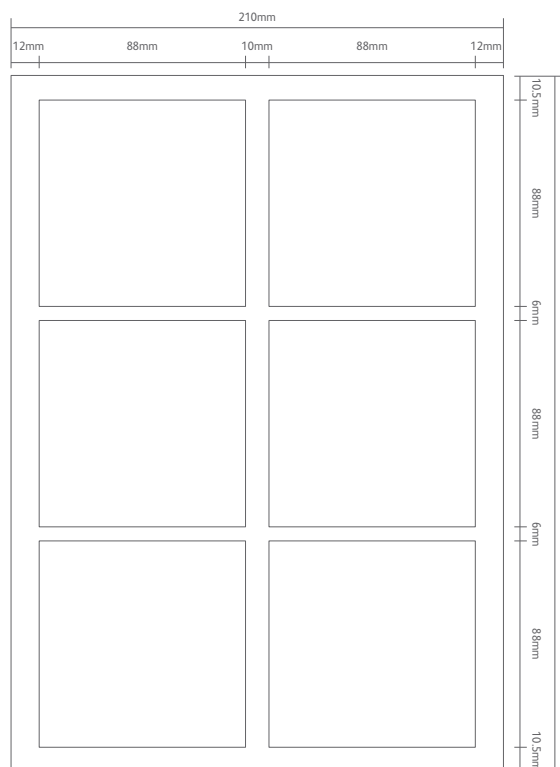



6 OUT



antalis <sup>TM</sup>  
Just ask Antalis



PRODUCT DETAILS

Xerox Product Code <b>003R98871</b>	Antalis Product Code <b>98398</b>	Description <b>FROSTED MAGAZINE FILE</b>
Supp Product Code <b>XMF</b>		Insert Sheet Size <b>210 x 297mm</b>
Supp Design No. <b>D5684</b>		Insert Paper <b>120gsm DRY PEEL</b>
Size <b>104(w) x 325(h) x 257(d)mm</b>		Items Per Box: <b>x20 FILES</b> <b>x5 SHEETS</b> <b>(30 inserts)</b>
Cover Material <b>FROSTED PP</b>		

PACKAGING DETAILS

Outer Case Design No. <b>D5738</b>	I.D. <b>405 x 335 x 365mm</b>
Style <b>0201 GLUED</b>	O.D. <b>421 x 351 x 397mm</b>
Material <b>150KT BC FLUTE</b>	Case Weight <b>13Kg</b>

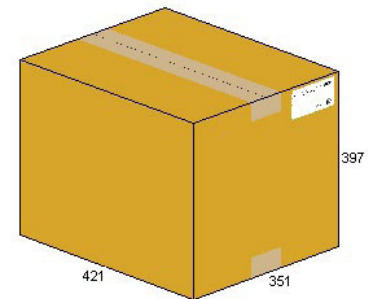

PALLETISATION DETAILS

UK Pallet 1200 x 1000mm

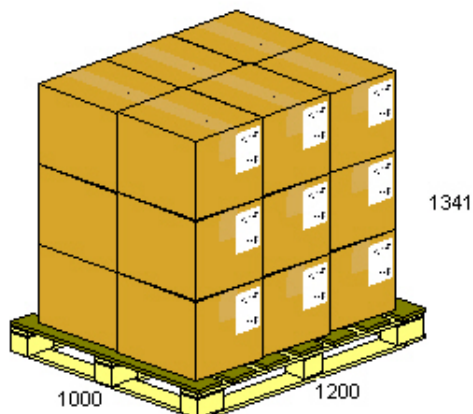

Cases / Layer <b>6</b>	Layers <b>3</b>	Total Cases <b>18</b>
Items / Load <b>360 FILES</b>		
Load Weight (inc pallet) <b>259Kg</b>		

CASE LABELLING DETAILS



Create Range  
FROSTED MAGAZINE FILE

**x20**

**x5 sheets**

**(30 inserts)**



5 01753 98871

**003R98871**

13Kg  
MADE IN EU

## FROSTED MAGAZINE FILE - ASSEMBLY INSTRUCTIONS

- 1** Lay the main panel flat with the display area window underneath so you are viewing the inside of the file.  
Fold the side panels up vertically.

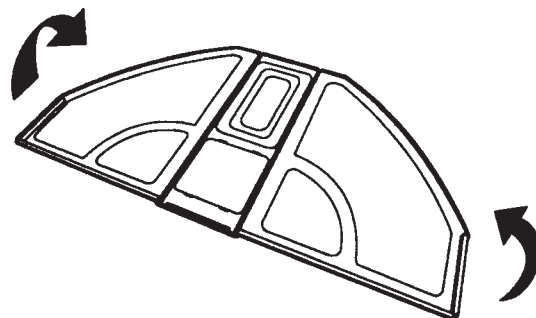

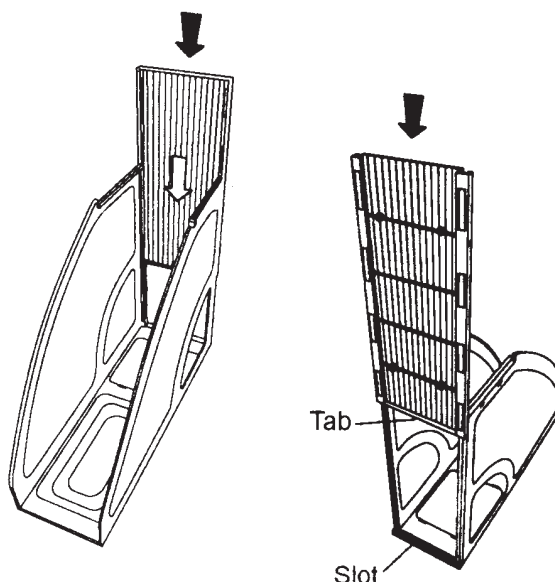

- 2** Slide the base panel onto the runners located on the bottom of each side panel ensuring the base arrow is pointing downward.  
Push and slide the base panel down completely so that the tab locks into the slot.

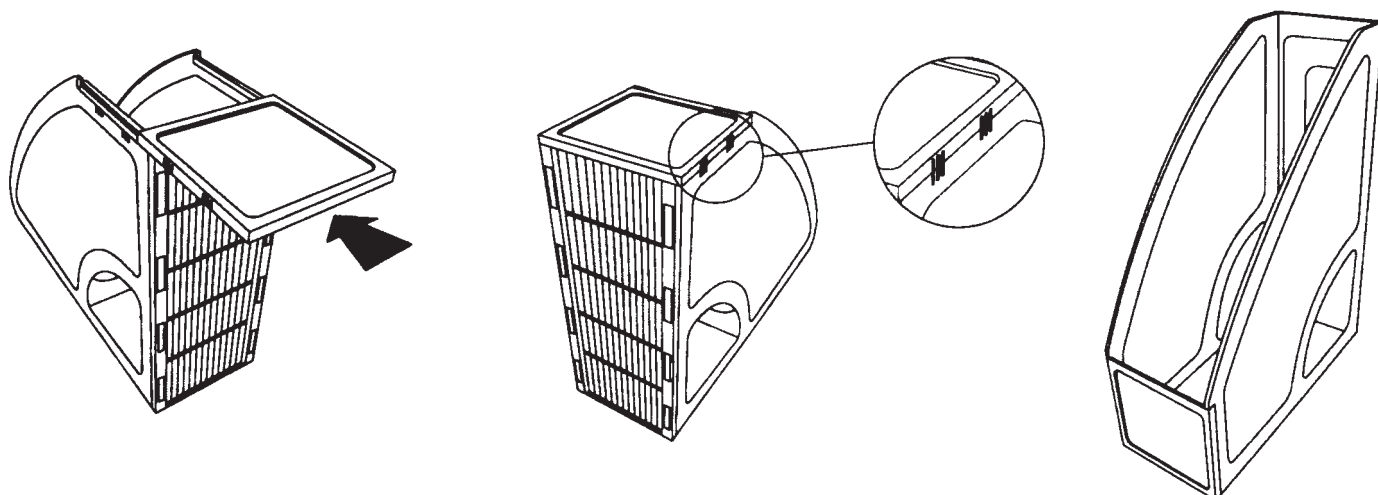

- 3** Slide the front panel along the runners located on the front of each side panel until the six notches on each side are aligned and it clicks into place.

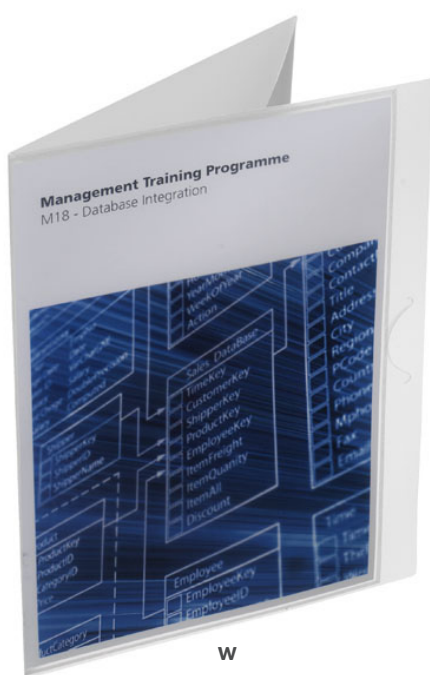

<b>Description</b> <b>A4 FLAT FOLDER</b>	<b>This Box Contains</b> <b>x50 FOLDERS</b> <b>x55 INSERTS</b>
 <p><b>d</b></p> <p><b>w</b></p> <p><b>h</b></p>	<b>Cover Material</b> <b>Polypropylene</b>  <b>100% Recyclable</b>
<b>Size</b> <b>240(w) x 309(h) x 3(d)mm</b>	

## Insert Sheet & Template

<b>Insert Sheet</b> 160gsm COLOUR IMPRESSIONS	<b>Size</b> 210 x 297mm	<a href="http://www.xerox.com">www.xerox.com</a> <a href="http://www.xerox.co.uk/printer-supplies/printing-templates">http://www.xerox.co.uk/printer-supplies/printing-templates</a>
--	----------------------------	---

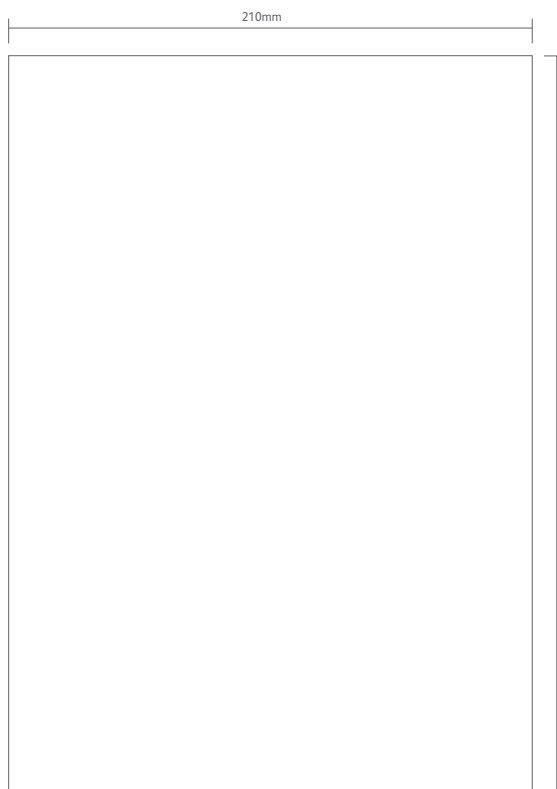



antalis <sup>TM</sup>  
 Just ask Antalis





PRODUCT DETAILS

Xerox Product Code <b>003R98799</b>	Antalis Product Code <b>64242</b>	Description <b>A4 FLAT FOLDER</b>
Supp Product Code <b>XFF</b>		Insert Sheet Size <b>210 x 297mm</b>
Supp Design No. <b>D5299</b>		Insert Paper <b>160gsm COLOUR IMPRESSIONS</b>
Size <b>240(w) x 309(h) x 3(d)mm</b>		Items Per Box: <b>x50 FOLDERS</b> <b>x55 INSERTS</b>
Cover Material <b>0.5mm ICE PP</b>		

PACKAGING DETAILS

Outer Case Design No. <b>D5201</b>	I.D. <b>315x 245 x 130mm</b>
Style <b>0201 GLUED</b>	O.D. <b>331 x 261 x 162mm</b>
Material <b>150KT BC FLUTE</b>	Case Weight <b>5.3Kg</b>

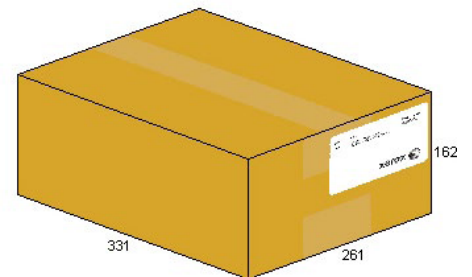

PALLETISATION DETAILS

UK Pallet 1200 x 1000mm

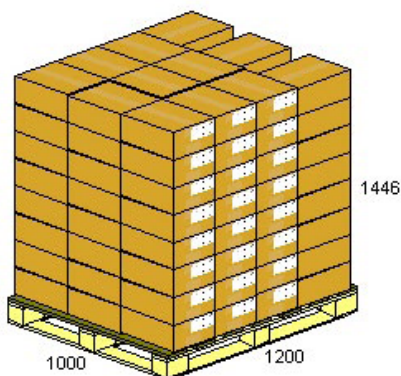

CASE LABELLING DETAILS

**xerox** 

Create Range  
A4 FLAT FOLDER

x50

x55 inserts





5 01753 98799

003R98799

5.3Kg  
MADE IN EU

Cases / Layer	Layers	Total Cases
<b>12</b>	<b>8</b>	<b>96</b>
Items / Load		
<b>4,800 FOLDERS</b>		
Load Weight (inc pallet)		
<b>534Kg</b>		

<p>Description</p> <p><b>A4 FILE BOX 20mm CAPACITY</b></p>	<p>This Box Contains</p> <p><b>x50 FILE BOXES</b></p> <p><b>x55 INSERTS</b></p>
	<p>Cover Material</p> <p><b>Polypropylene</b></p>  <p><b>100% Recyclable</b></p>
	<p>Size</p> <p><b>240(w) x 309(h) x 20(d)mm</b></p>

## Insert Sheet & Template

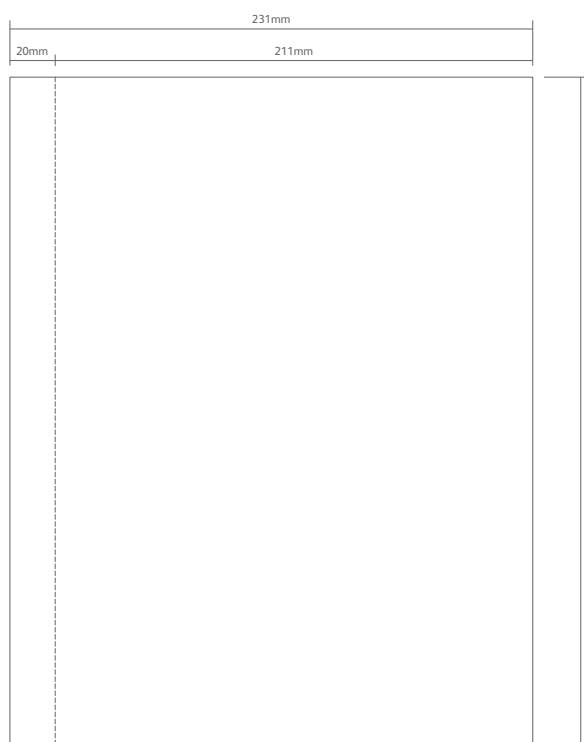

<p>Insert Sheet</p> <p>160gsm COLOUR IMPRESSIONS</p>	<p>Size</p> <p>231 x 297mm</p>	<p>Download template at</p> <p><a href="http://www.TheCreateRange.co.uk">www.TheCreateRange.co.uk</a></p>
--	--------------------------------	---



antalis <sup>TM</sup>  
Just ask Antalis



PRODUCT DETAILS

Xerox Product Code <b>003R98873</b>	Antalis Product Code <b>67166</b>	Description <b>A4 FILE BOX 20mm CAPACITY</b>
Supp Product Code <b>XB20</b>		Insert Sheet Size <b>231 x 297mm</b>
Supp Design No. <b>D4352</b>		Insert Paper <b>160gsm COLOUR IMPRESSIONS</b>
Size <b>240(w) x 309(h) x 20(d)mm</b>		Items Per Box: <b>x50 FILE BOXES</b> <b>x55 INSERTS</b>
Cover Material <b>0.8mm ICE PP</b>		

PACKAGING DETAILS

Outer Case Design No. <b>D5735</b>	I.D. <b>643x 64 x 473mm</b>
Style <b>0203 GLUED</b>	O.D. <b>659 x 96 x 489mm</b>
Material <b>150KT BC FLUTE</b>	Case Weight <b>8.7Kg</b>

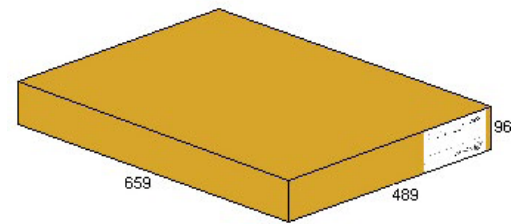

PALLETISATION DETAILS

UK Pallet 1200 x 1000mm
-------------------------

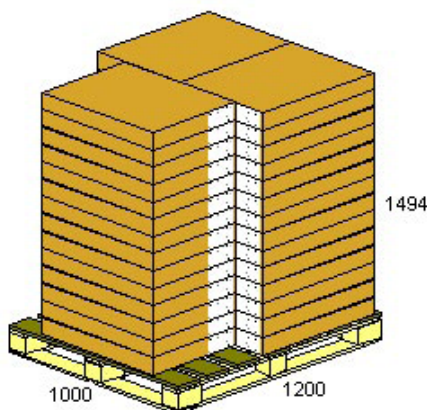

Cases / Layer	Layers	Total Cases
<b>3</b>	<b>14</b>	<b>42</b>
Items / Load <b>2,100 FILE BOXES</b>		
Load Weight (inc pallet) <b>390Kg</b>		

CASE LABELLING DETAILS

**xerox** 

Create Range  
A4 FILE BOX 20MM CAPACITY

x50

x55 inserts



003R98873

8.7Kg  
MADE IN EU

<p>Description</p> <p><b>A4 FILE BOX 40mm CAPACITY</b></p>	<p>This Box Contains</p> <p><b>x50 FILE BOXES</b></p> <p><b>x55 INSERTS</b></p>
	<p>Cover Material</p> <p><b>Polypropylene</b></p>  <p><b>100% Recyclable</b></p>
	<p>Size</p> <p><b>240(w) x 309(h) x 40(d)mm</b></p>



## Insert Sheet & Template

<p>Insert Sheet</p> <p>160gsm COLOUR IMPRESSIONS</p>	<p>Size</p> <p>250 x 297mm</p>	<p>Download template at</p> <p><a href="http://www.TheCreateRange.co.uk">www.TheCreateRange.co.uk</a></p>
--	--------------------------------	---

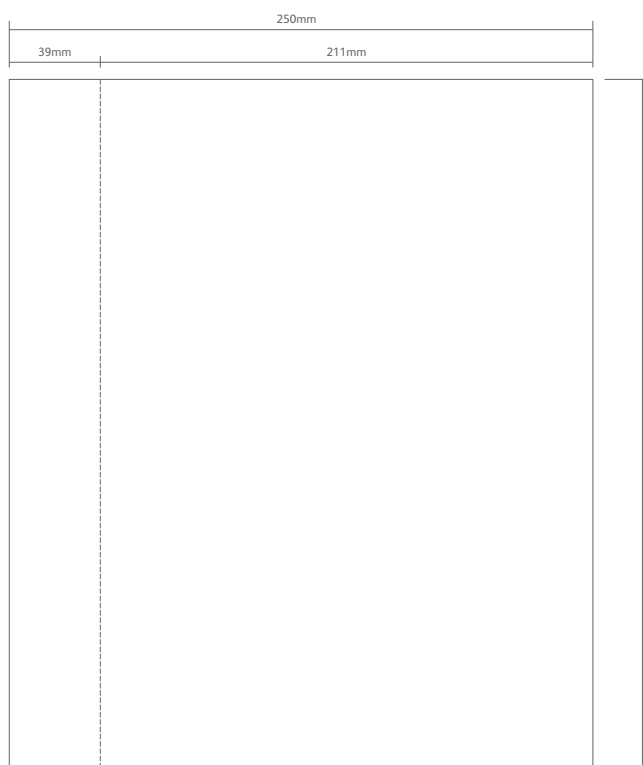

PRODUCT DETAILS

Xerox Product Code <b>003R98872</b>	Antalis Product Code <b>67167</b>	Description <b>A4 FILE BOX 40mm CAPACITY</b>
Supp Product Code <b>XB40</b>		Insert Sheet Size <b>250 x 297mm</b>
Supp Design No. <b>D4350</b>		Insert Paper <b>160gsm COLOUR IMPRESSIONS</b>
Size <b>240(w) x 309(h) x 40(d)mm</b>		Items Per Box: <b>x50 FILE BOXES x55 INSERTS</b>
Cover Material <b>0.8mm ICE PP</b>		

PACKAGING DETAILS

Outer Case Design No. <b>D5735</b>	I.D. <b>643x 64 x 473mm</b>
Style <b>0203 GLUED</b>	O.D. <b>659 x 96 x 489mm</b>
Material <b>150KT BC FLUTE</b>	Case Weight <b>10.2Kg</b>

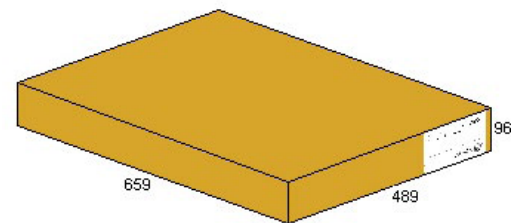

PALLETISATION DETAILS

UK Pallet 1200 x 1000mm
-------------------------

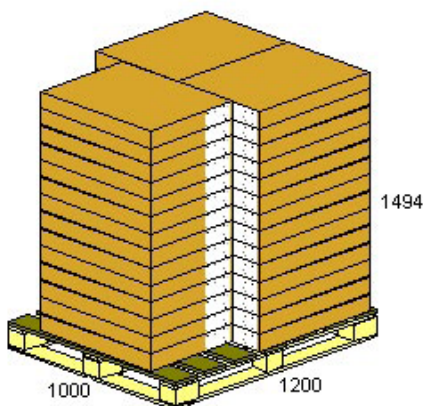

Cases / Layer	Layers	Total Cases
<b>3</b>	<b>14</b>	<b>42</b>
Items / Load <b>2,100 FILE BOXES</b>		
Load Weight (inc pallet) <b>453Kg</b>		

CASE LABELLING DETAILS



Create Range  
A4 FILE BOX 40MM CAPACITY

x50



x55 inserts



5 01753 98872

10.2Kg  
MADE IN EU

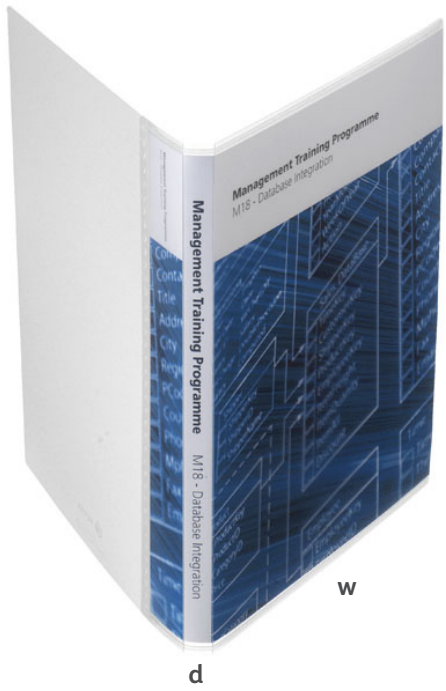
# 003R98872

<p>Description</p> <p><b>A4 COIL / WIRO COVER</b></p>	<p>This Box Contains</p> <p><b>x50 COVERS</b></p> <p><b>x55 INSERTS</b></p>
	<p>Cover Material</p> <p><b>Polypropylene</b></p>  <p><b>100% Recyclable</b></p>
	<p>Size</p> <p><b>226(w) x 309(h) x 16(d)mm</b></p>



## Insert Sheet & Template

<p>Insert Sheet</p> <p>160gsm COLOUR IMPRESSIONS</p>	<p>Size</p> <p>275 x 297mm</p>	<p>Download template at</p> <p><a href="http://www.TheCreateRange.co.uk">www.TheCreateRange.co.uk</a></p>
--	--------------------------------	---

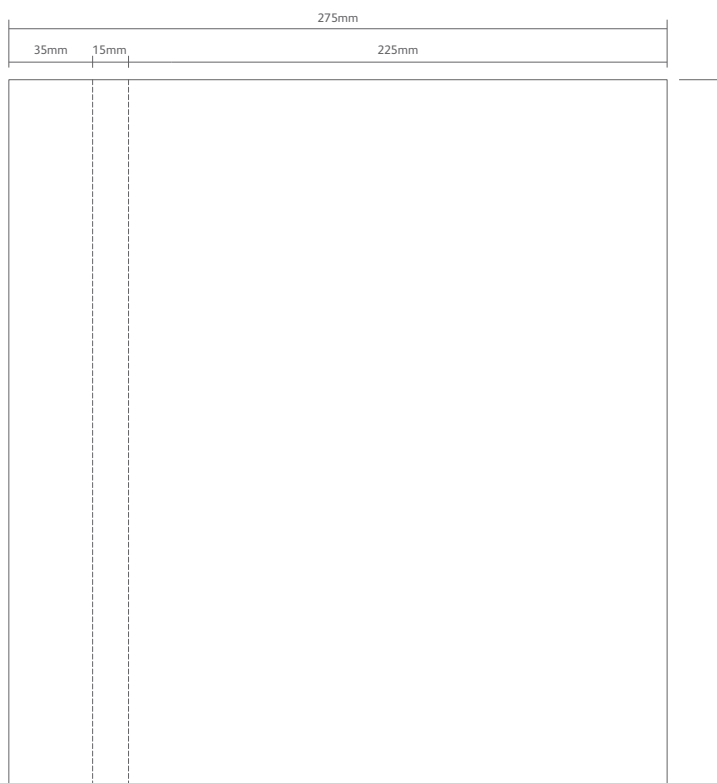

PRODUCT DETAILS

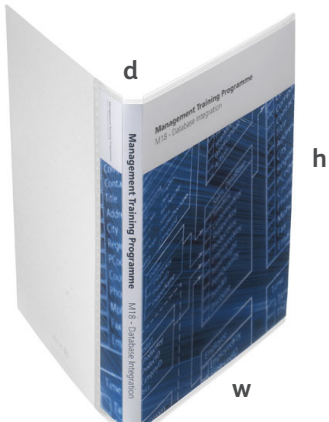
Xerox Product Code <b>003R98888</b>	Antalis Product Code <b>67168</b>	Description <b>A4 COIL / WIRO COVER</b>
Supp Product Code <b>XCW</b>		
Supp Design No. <b>D5289</b>		
Size <b>226(w) x 309(h) x 16(d)mm</b>		
Cover Material <b>0.5mm ICE PP</b>		
Insert Sheet Size <b>275 x 297mm</b>		Insert Paper <b>160gsm COLOUR IMPRESSIONS</b>
Items Per Box: <b>x50 COVERS</b> <b>x55 INSERTS</b>		

PACKAGING DETAILS

Outer Case Design No. <b>D5806</b>	I.D. <b>470 x 312 x 68mm</b>
Style <b>0201 GLUED</b>	O.D. <b>486 x 328 x 100mm</b>
Material <b>150KT BC FLUTE</b>	Case Weight <b>5Kg</b>

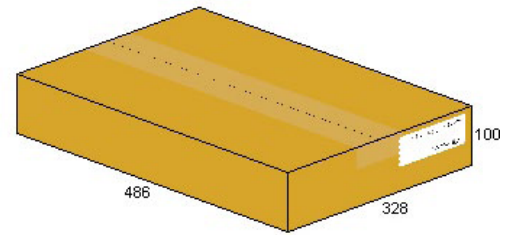

PALLETISATION DETAILS

UK Pallet 1200 x 1000mm

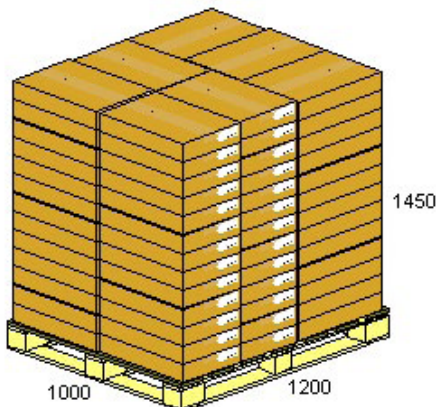

Cases / Layer <b>7</b>	Layers <b>13</b>	Total Cases <b>91</b>
Items / Load <b>4,550 COVERS</b>		
Load Weight (inc pallet) <b>480Kg</b>		

CASE LABELLING DETAILS



Create Range  
A4 COIL / WIRO COVER



**x50**  
**x55 inserts**



5 01753 98888

5Kg  
MADE IN EU

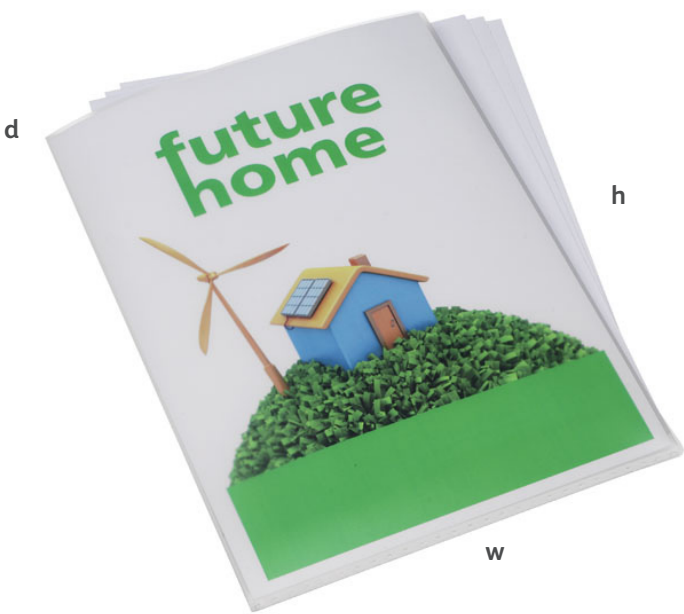
# 003R98888

<p>Description</p> <p><b>A4 LETTER FILE</b></p>	<p>This Box Contains</p> <p><b>x50 FILES</b> <b>x55 INSERTS</b></p>
	<p>Cover Material</p> <p><b>Polypropylene</b></p>  <p><b>100% Recyclable</b></p>
	<p>Size</p> <p><b>218(w) x 308(h) x 2(d)mm</b></p>

## Insert Sheet & Template

<p>Insert Sheet</p> <p>160gsm COLOUR IMPRESSIONS</p>	<p>Size</p> <p>210 x 297mm</p>	<p>Download template at</p> <p><a href="http://www.TheCreateRange.co.uk">www.TheCreateRange.co.uk</a></p>
--	--------------------------------	---

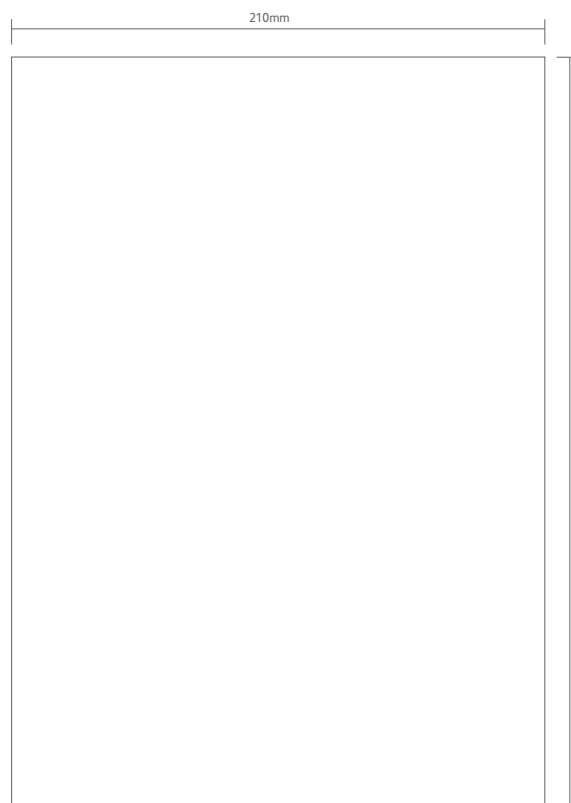



PRODUCT DETAILS

Xerox Product Code <b>003R98879</b>	Antalis Product Code <b>67188</b>	Description <b>A4 LETTER FILE</b>
Supp Product Code <b>XLF</b>		Insert Sheet Size <b>210 X 297mm</b>
Supp Design No. <b>D4634</b>		Insert Paper <b>160gsm COLOUR IMPRESSIONS</b>
Size <b>218(w) x 308(h) x 2(d)mm</b>		Items Per Box: <b>x50 FILES</b> <b>x55 INSERTS</b>
Cover Material <b>0.28mm SATIN PP</b>		

PACKAGING DETAILS

Outer Case Design No. <b>D5894</b>	I.D. <b>315x 220 x 80mm</b>
Style <b>0201 GLUED</b>	O.D. <b>331 x 236 x 112mm</b>
Material <b>150KT BC FLUTE</b>	Case Weight <b>3.3Kg</b>

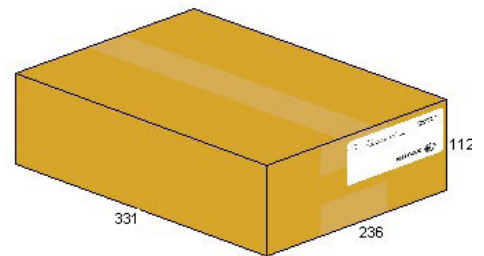

PALLETISATION DETAILS

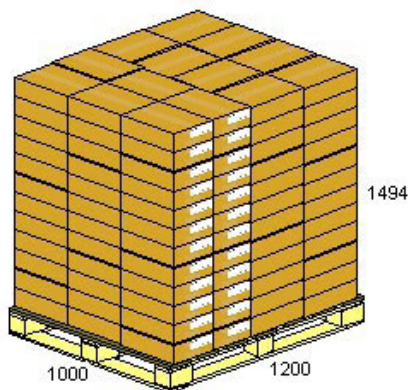

UK Pallet 1200 x 1000mm



Cases / Layer	Layers	Total Cases
<b>14</b>	<b>12</b>	<b>168</b>
Items / Load		
<b>8,400 FILES</b>		
Load Weight (inc pallet)		
<b>579Kg</b>		

CASE LABELLING DETAILS



<p>Description</p> <p><b>A4 LANDSCAPE FLAT FOLDER</b></p>	<p>This Box Contains</p> <p><b>x100 FOLDERS</b>  <b>x40 SHEETS</b>  <b>(120 inserts)</b></p>
	<p>Cover Material</p> <p><b>Polypropylene</b></p>  <p><b>100% Recyclable</b></p>
<p>Size</p> <p><b>320(w) x 240(h) x 2(d)mm</b></p>	

## Insert Sheet & Template

<p>Insert Sheet</p> <p>160gsm COLOUR IMPRESSIONS</p>	<p>Size</p> <p>210 x 297mm</p>	<p>Download template at</p> <p><a href="http://www.TheCreateRange.co.uk">www.TheCreateRange.co.uk</a></p>
--	--------------------------------	---



antalis <sup>TM</sup>  
 Just ask Antalis

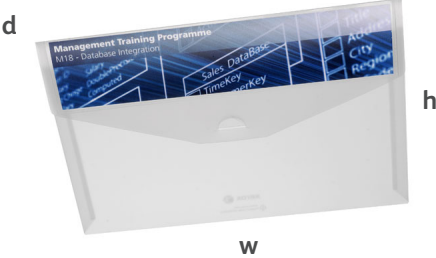

PRODUCT DETAILS

Xerox Product Code <b>003R93542</b>	Antalis Product Code <b>67170</b>	Description <b>A4 LANDSCAPE FLAT FOLDER</b>
Supp Product Code <b>XLDF</b>		Insert Sheet Size <b>210 x 297mm</b>
Supp Design No. <b>D4635</b>		Insert Paper <b>160gsm COLOUR IMPRESSIONS</b>
Size <b>321(w) x 240(h) x 3(d)mm</b>		Items Per Box: <b>x100 FOLDERS x40 SHEETS (120 inserts)</b>
Cover Material <b>0.5mm FROSTED PP</b>		

PACKAGING DETAILS

Outer Case Design No. <b>D6526</b>	I.D. <b>330 x 295 x 255mm</b>
Style <b>0201 GLUED</b>	O.D. <b>346 x 311 x 287mm</b>
Material <b>150KT BC FLUTE</b>	Case Weight <b>9.2Kg</b>

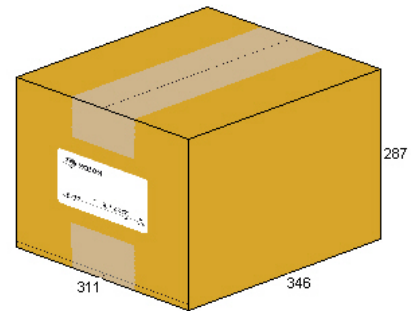

PALLETISATION DETAILS

UK Pallet 1200 x 1000mm

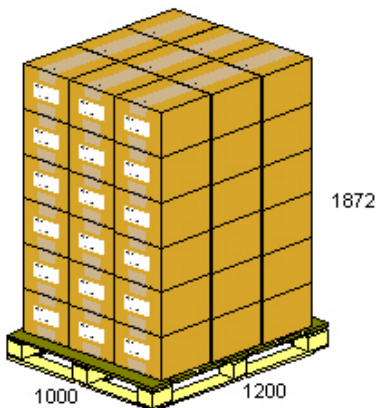

Cases / Layer <b>9</b>	Layers <b>6</b>	Total Cases <b>54</b>
Items / Load <b>5,400 FOLDERS</b>		
Load Weight (inc pallet) <b>497Kg</b>		

CASE LABELLING DETAILS

**xerox** 

Create Range  
A4 LANDSCAPE FLAT FOLDER

x100  
x40 sheets  
(120 inserts)



5 01753 93542

003R93542

9.2Kg  
MADE IN EU

Description	<b>A4 TOTEM DISPLAY UNIT</b>
-------------	------------------------------

This Box Contains <b>x20 DISPLAYS</b> <b>x44 INSERTS</b>
--

Cover Material Polypropylene  100% Recyclable
---

Size <b>190(w) x 299(h) x 85(d)mm</b>
--



## Insert Sheet & Template

Insert Sheet 160gsm COLOUR IMPRESSIONS	Size 210 x 297mm	Download template at <a href="http://www.TheCreateRange.co.uk">www.TheCreateRange.co.uk</a>
---	---------------------	--

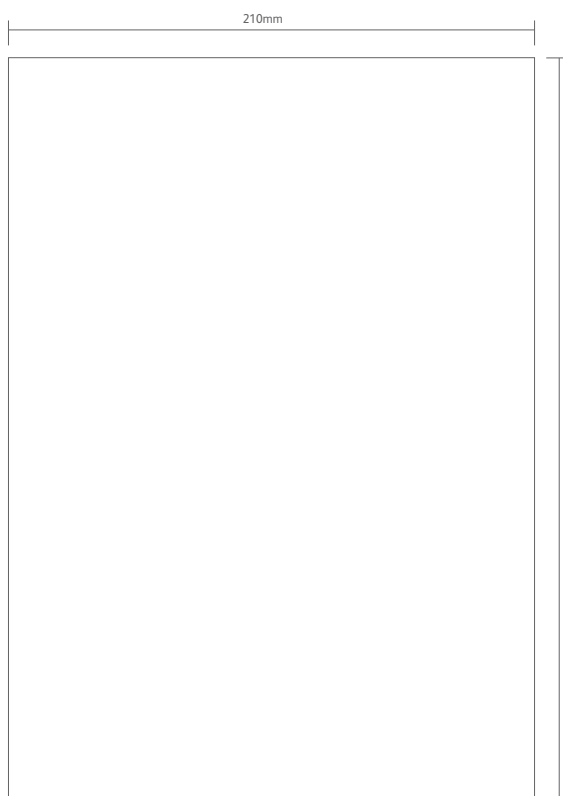

PRODUCT DETAILS

Xerox Product Code <b>003R98880</b>	Antalis Product Code <b>83409</b>	Description <b>A4 TOTEM DISPLAY UNIT</b>
Supp Product Code <b>XDU</b>		Insert Sheet Size <b>210 x 297mm</b>
Supp Design No. <b>D5171</b>		Insert Paper <b>160gsm COLOUR IMPRESSIONS</b>
Size <b>190(w) x 299(h) x 85(d)mm</b>		Items Per Box: <b>x20 DISPLAYS</b> <b>x44 INSERTS</b>
Cover Material <b>0.8mm GLOSS PP</b>		

PACKAGING DETAILS

Outer Case Design No. <b>D6130</b>	I.D. <b>305 x 220 x 420mm</b>
Style <b>0201 GLUED</b>	O.D. <b>321 x 236 x 452 mm</b>
Material <b>150KT BC FLUTE</b>	Case Weight <b>3.8Kg</b>

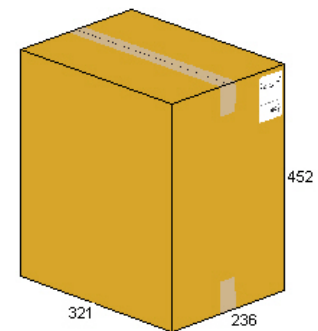

PALLETISATION DETAILS

UK Pallet 1200 x 1000mm
-------------------------

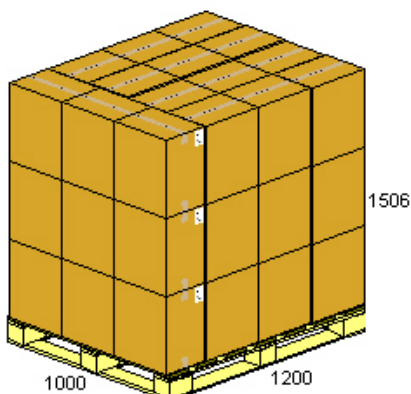

Cases / Layer	Layers	Total Cases
<b>15</b>	<b>3</b>	<b>45</b>
Items / Load <b>900 DISPLAYS</b>		
Load Weight (inc pallet) <b>196Kg</b>		

CASE LABELLING DETAILS

**xerox** 

Create Range  
A4 TOTEM DISPLAY UNIT

x20

x44 inserts



5 01753 98880

003R98880

3.8Kg  
MADE IN EU

<p>Description</p> <p><b>A3 TOTEM DISPLAY UNIT</b></p>	<p>This Box Contains</p> <p><b>x10 DISPLAYS</b></p> <p><b>x22 SHEETS</b></p>
 <p>The image shows a cylindrical display unit with a dark background. The text on the unit reads: "Welcome to the Royal Oak Hotel" in a mix of serif and script fonts. Below this is a photograph of a large, multi-story stone building. At the bottom, it says "This way to Reception" with a white arrow pointing to the right. Dimensions are indicated: 'd' for diameter, 'w' for width, and 'h' for height.</p>	<p>Panel Material</p> <p><b>Polypropylene</b></p>  <p><b>100% Recyclable</b></p>
	<p>Size</p> <p><b>281(w) x 427(h) x 118(d)mm</b></p>

## Insert Sheet & Template

<p>Insert Sheet</p> <p>250gsm COLOUR IMPRESSIONS</p>	<p>Size</p> <p>297 x 420mm</p>	<p>Download template at</p> <p><a href="http://www.TheCreateRange.co.uk">www.TheCreateRange.co.uk</a></p>
--	--------------------------------	---



PRODUCT DETAILS

Xerox Product Code <b>003R95083</b>	Antalis Product Code <b>83802</b>	Description <b>A3 Totem Display Unit</b>
Supp Product Code <b>XTA3</b>		Insert Sheet Size <b>420mm x 297mm</b>
Supp Design No. <b>D6456</b>		Insert Paper <b>250gsm COLOUR IMPRESSIONS</b>
Size <b>282(w) x 427(h) x 118(d)mm</b>		Items Per Box: <b>x10 DISPLAYS x22 INSERTS</b>
Cover Material <b>0.5mm Gloss Clear PP</b>		

PACKAGING DETAILS

Outer Case Design No. <b>D6600</b>	I.D. <b>430 x 306 x 330mm</b>
Style <b>0201 GLUED</b>	O.D. <b>446 x 322 x 362mm</b>
Material <b>150KT BC FLUTE</b>	Case Weight <b>4.5 Kg</b>

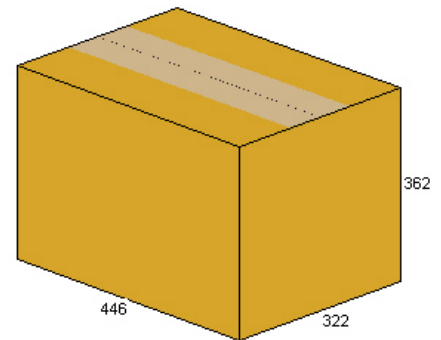

PALLETISATION DETAILS

UK Pallet 1200 x 1000mm

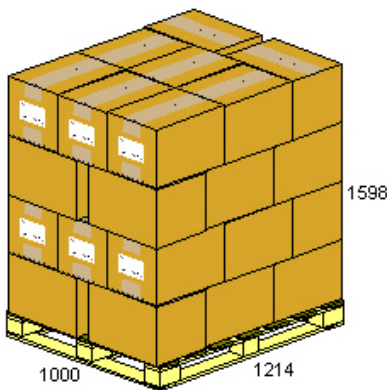

Cases / Layer <b>8</b>	Layers <b>4</b>	Total Cases <b>32</b>
Items / Load <b>320 DISPLAYS</b>		
Load Weight (inc pallet) <b>169Kg</b>		

CASE LABELLING DETAILS



<p>Description</p> <p><b>iGEN TOTEM DISPLAY UNIT</b></p>	<p>This Box Contains</p> <p><b>x1 DISPLAY</b></p> <p><b>x6 SHEETS</b></p>
	<p>Panel Material</p> <p>PET</p>  <p>PET</p> <p><b>100% Recyclable</b></p>
	<p>Size</p> <p><b>360(w) x 668(h) x 130(d)mm</b></p>

## Insert Sheet & Template

<p>Insert Sheet</p> <p>250gsm COLOUR IMPRESSIONS</p>	<p>Size</p> <p>660 x 364mm</p>	<p>Download template at</p> <p><a href="http://www.TheCreateRange.co.uk">www.TheCreateRange.co.uk</a></p>
--	--------------------------------	---

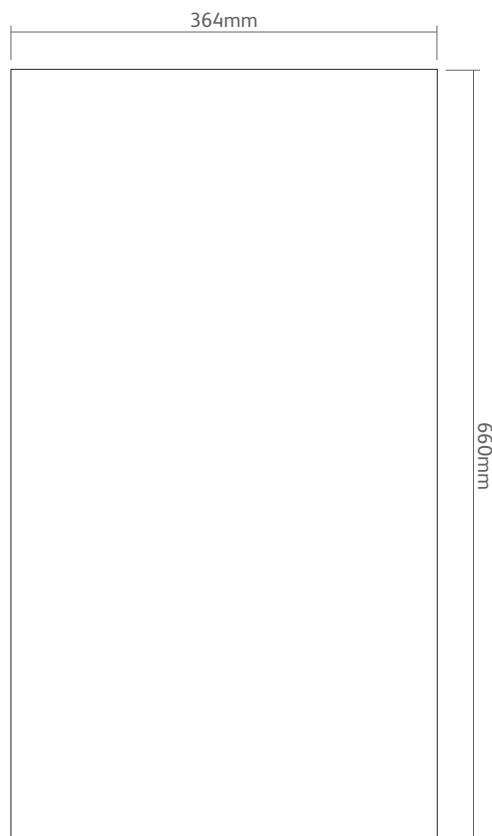



PRODUCT DETAILS

Xerox Product Code <b>003R95084</b>	Antalis Product Code <b>83800</b>	Description <b>iGEN Totem Display Unit</b>
Supp Product Code <b>XIGEN</b>		Insert Sheet Size <b>660 x 364mm</b>
Supp Design No. <b>D6458</b>		Insert Paper <b>250gsm COLOUR IMPRESSIONS</b>
Size <b>360(w) x 668(h) x 130(d)mm</b>		Items Per Box: <b>x1 DISPLAY x6 INSERTS</b>
Cover Material <b>0.5mm CLEAR PET</b>		

PACKAGING DETAILS

Outer Case Design No. <b>D6474</b>	I.D. <b>665 x 366 x 45mm</b>
Style <b>SLOTTED WRAP</b>	O.D. <b>679 x 380 x 62mm</b>
Material <b>150KT B FLUTE</b>	Case Weight <b>1.4 Kg</b>

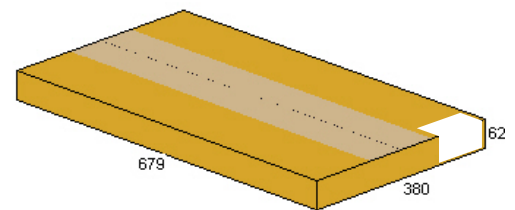

PALLETISATION DETAILS

UK Pallet 1200 x 1000mm

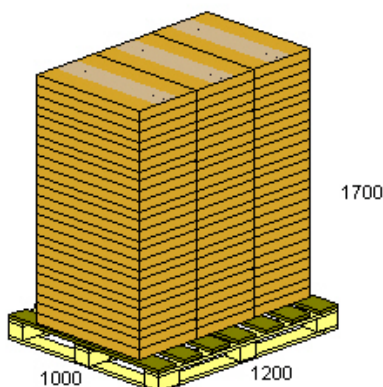

Cases / Layer	Layers	Total Cases
<b>3</b>	<b>25</b>	<b>75</b>
Items / Load <b>75 DISPLAYS</b>		
Load Weight (inc pallet) <b>130 Kg</b>		

CASE LABELLING DETAILS

Create Range  
IGEN TOTEM DISPLAY

**x1** **x6 inserts**

**003R95084**

 5 017534 950843

Create Range  
IGEN TOTEM DISPLAY

**x1** **x6 inserts**

**003R95084**

 5 017534 950843

1.4Kg

MADE IN EU

<b>Description</b>	<b>900 TOTEM DISPLAY UNIT</b>
--------------------	-------------------------------

<b>This Box Contains</b> x1 DISPLAY x6 SHEETS
---

<b>Panel Material</b> PET  PET 100% Recyclable
---

<b>Size</b> 387(w) x 925(h) x 287(d)mm
---



## Insert Sheet & Template

<b>Insert Sheet</b> 250gsm COLOUR IMPRESSIONS	<b>Size</b> 900 x 210mm	<b>Download template at</b> <a href="http://www.TheCreateRange.co.uk">www.TheCreateRange.co.uk</a>
--	----------------------------	---

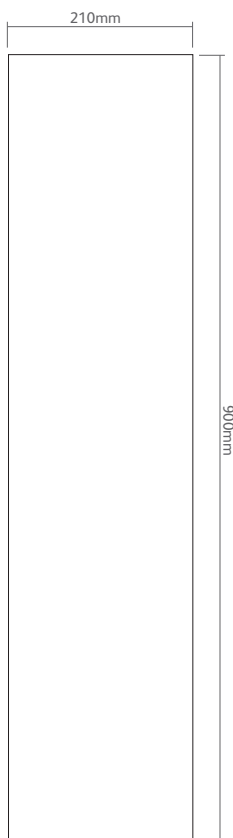

PRODUCT DETAILS

Xerox Product Code <b>003R95085</b>	Antalis Product Code <b>83801</b>	Description <b>900 Totem Display Unit</b>
Supp Product Code <b>XT900</b>		Insert Sheet Size <b>900 x 210mm</b>
Supp Design No. <b>D6507</b>		Insert Paper <b>250gsm COLOUR IMPRESSIONS</b>
Size <b>387(w) x 925(h) x 287(d)mm</b>		Items Per Box: <b>x1 DISPLAY</b> <b>x6 INSERTS</b>
Cover Material <b>0.5mm CLEAR PET</b>		

PACKAGING DETAILS

Outer Case Design No. <b>D6554</b>	I.D. <b>914 x 288 x 47mm</b>
Style <b>SLOTTED WRAP</b>	O.D. <b>928 x 302 x 64mm</b>
Material <b>150KT B FLUTE</b>	Case Weight <b>1.6 Kg</b>

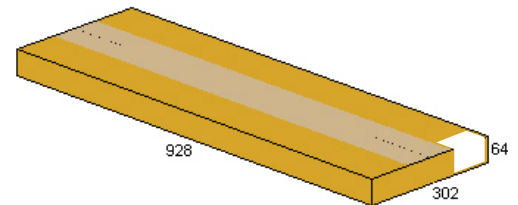

PALLETISATION DETAILS

UK Pallet 1200 x 1000mm

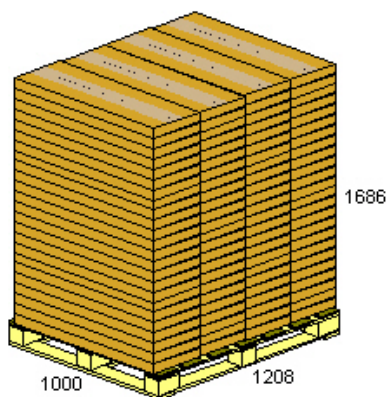

Cases / Layer	Layers	Total Cases
<b>4</b>	<b>24</b>	<b>96</b>
Items / Load		
<b>96 DISPLAYS</b>		
Load Weight (inc pallet)		
<b>178 Kg</b>		

CASE LABELLING DETAILS

Create Range  
900 TOTEM DISPLAY

**x1** **x6 inserts**

**003R95085**

 5 017534 950850

Create Range  
900 TOTEM DISPLAY

**x1** **x6 inserts**

**003R95085**

 5 017534 950850

1.6Kg

MADE IN EU

<b>Description</b> <b>900 TOTEM DISPLAY UNIT INSERT SHEETS</b>	<b>This Pack Contains</b> <b>x50 INSERTS</b>
--	---



<b>Material</b>  250gsm COLOUR IMPRESSIONS  <b>100% Recyclable</b>
--

<b>Size</b> <b>387(w) x 925(h) x 287(d)mm</b>
--

## Insert Sheet & Template

<b>Insert Sheet</b> 250gsm COLOUR IMPRESSIONS	<b>Size</b> 900 x 210mm	<b>Download template at</b> <a href="http://www.TheCreateRange.co.uk">www.TheCreateRange.co.uk</a>
--	----------------------------	---

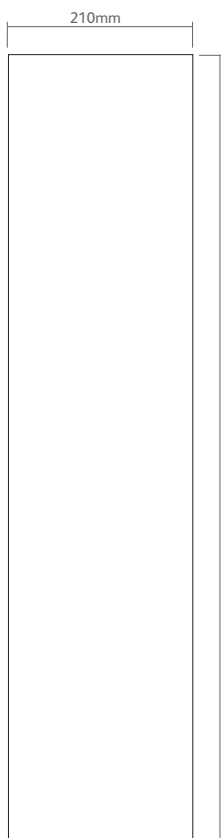

PRODUCT DETAILS

Xerox Product Code <b>003R94998</b>	Antalis Product Code <b>61241</b>	Description <b>900 Totem Display Unit Insert Sheets</b>
Supp Product Code *		Insert Sheet Size <b>900 x 210mm</b>
Supp Design No. <b>D6580</b>		Insert Paper <b>250gsm COLOUR IMPRESSIONS</b>
Size		Items Per Box: <b>x50 INSERTS</b>
Cover Material		

PACKAGING DETAILS

Outer Case Design No. <b>D6580</b>	I.D. <b>900 x 210x 19mm</b>
Style <b>DIE CUT ENVELOPE</b>	O.D. <b>1006 x 220 x 31mm</b>
Material <b>150KT B FLUTE</b>	Case Weight <b>3.2 Kg</b>

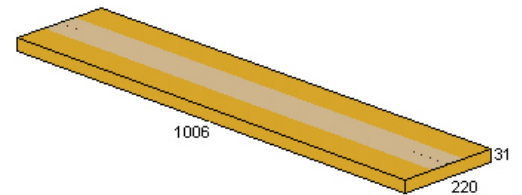

PALLETISATION DETAILS

UK Pallet 1200 x 1000mm
-------------------------

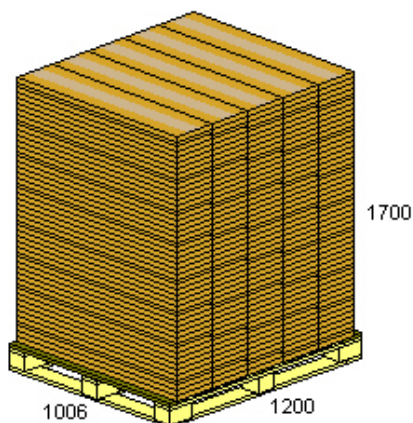

Cases / Layer	Layers	Total Cases
<b>5</b>	<b>50</b>	<b>250</b>
Items / Load <b>250 PACKS</b>		
Load Weight (inc pallet) <b>825 Kg</b>		

CASE LABELLING DETAILS



Description	<b>1200 TOTEM DISPLAY UNIT</b>
-------------	--------------------------------

This Box Contains <b>x1 DISPLAY</b> <b>x6 SHEETS</b>
--

Panel Material PET  PET <b>100% Recyclable</b>
---

Size <b>512(w) x 1213(h) x 348(d)mm</b>
--



## Insert Sheet & Template

Insert Sheet 250gsm COLOUR IMPRESSIONS	Size 1200 x 297mm	Download template at <a href="http://www.TheCreateRange.co.uk">www.TheCreateRange.co.uk</a>
---	----------------------	--

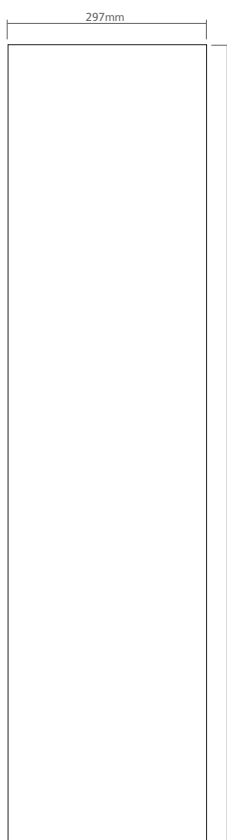

PRODUCT DETAILS

Xerox Product Code <b>003R95086</b>	Antalis Product Code <b>83803</b>	Description <b>1200 Totem Display Unit</b>
Supp Product Code <b>XT1200</b>		Insert Sheet Size <b>1200 x 297mm</b>
Supp Design No. <b>D6498</b>		Insert Paper <b>250gsm COLOUR IMPRESSIONS</b>
Size <b>512(w) x 1213(h) x 348(d)mm</b>		Items Per Box: <b>x1 DISPLAY</b> <b>x6 INSERTS</b>
Cover Material <b>0.8mm CLEAR PET</b>		

PACKAGING DETAILS

Outer Case Design No. <b>D6548</b>	I.D. <b>1212 x 350 x 37mm</b>
Style <b>SLOTTED WRAP</b>	O.D. <b>1226 x 364 x 54mm</b>
Material <b>150KT B FLUTE</b>	Case Weight <b>2.1 Kg</b>

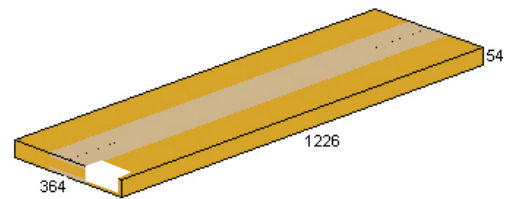

PALLETISATION DETAILS

UK Pallet 1200 x 1000mm

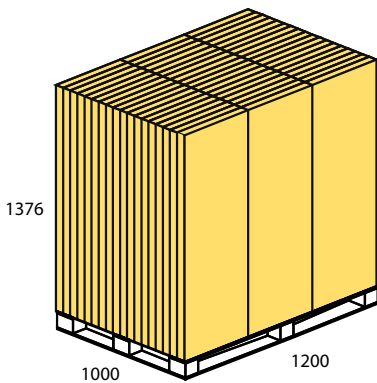

Rows	Per row	Total Cases
<b>3</b>	<b>18</b>	<b>54</b>

Items / Load  
**54 DISPLAYS**

Load Weight (inc pallet)  
**121 Kg**

CASE LABELLING DETAILS

Create Range  
1200 TOTEM DISPLAY

**x1** **x6 inserts**

**003R95086**

 5 017534 950867

Create Range  
1200 TOTEM DISPLAY

**x1** **x6 inserts**

**003R95086**

 5 017534 950867

2.1Kg

MADE IN EU

<b>Description</b> <b>1200 TOTEM DISPLAY UNIT INSERT SHEETS</b>	<b>This Pack Contains</b> <b>x50 INSERTS</b>
--	---



d

h

w

<b>Material</b>  250gsm COLOUR IMPRESSIONS  <b>100% Recyclable</b>
--

<b>Size</b> <b>512(w) x 1213(h) x 348(d)mm</b>
---

## Insert Sheet & Template

<b>Insert Sheet</b> 250gsm COLOUR IMPRESSIONS	<b>Size</b> 1200 x 297mm	<b>Download template at</b> <a href="http://www.TheCreateRange.co.uk">www.TheCreateRange.co.uk</a>
--	-----------------------------	---

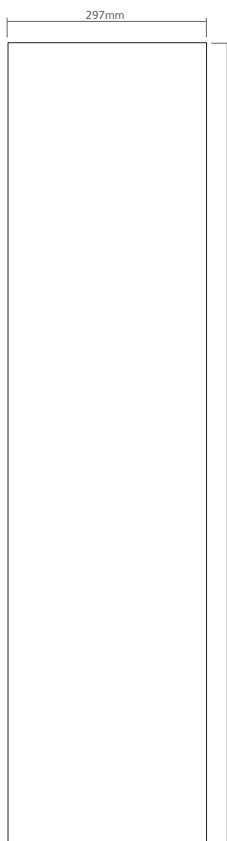

antalis <sup>TM</sup>  
 Just ask Antalis





PRODUCT DETAILS

Xerox Product Code <b>003R94999</b>	Antalis Product Code <b>61242</b>	Description <b>1200 Totem Display Unit Insert Sheets</b>
Supp Product Code *		Insert Sheet Size <b>1200 x 297mm</b>
Supp Design No. <b>D6581</b>		Insert Paper <b>250gsm COLOUR IMPRESSIONS</b>
Size		Items Per Box: <b>x50 INSERTS</b>
Cover Material		

PACKAGING DETAILS

Outer Case Design No. <b>D6581</b>	I.D. <b>1200 x 297 x 19mm</b>
Style <b>DIE CUT ENVELOPE</b>	O.D. <b>1306 x 307 x 31mm</b>
Material <b>150KT B FLUTE</b>	Case Weight <b>5.6 Kg</b>

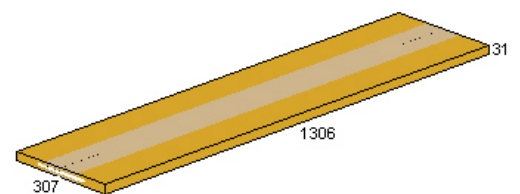

PALLETISATION DETAILS

UK Pallet 1500 x 1000mm
-------------------------

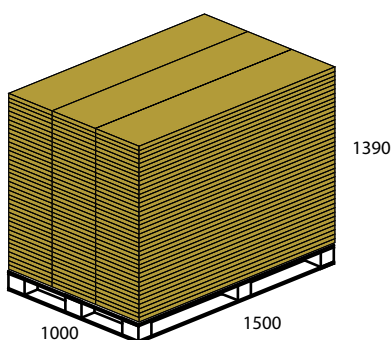

CASE LABELLING DETAILS



Cases / Layer	Layers	Total Cases
<b>3</b>	<b>40</b>	<b>120</b>
Items / Load <b>120 PACKS</b>		
Load Weight (inc pallet) <b>679 Kg</b>		

<b>Description</b> <b>1600 TOTEM DISPLAY UNIT</b>	<b>This Box Contains</b> <b>x1 DISPLAY</b>
--	---



<b>Panel Material</b> PET  PET <b>100% Recyclable</b>
--

<b>Size</b> <b>716(w) x 1613(h) x 444(d)mm</b>
---

## Insert Sheet & Template

<b>Insert Sheet</b> Not supplied	<b>Size</b> 1600 x 495mm	<b>Download template at</b> <a href="http://www.TheCreateRange.co.uk">www.TheCreateRange.co.uk</a>
-------------------------------------	-----------------------------	---

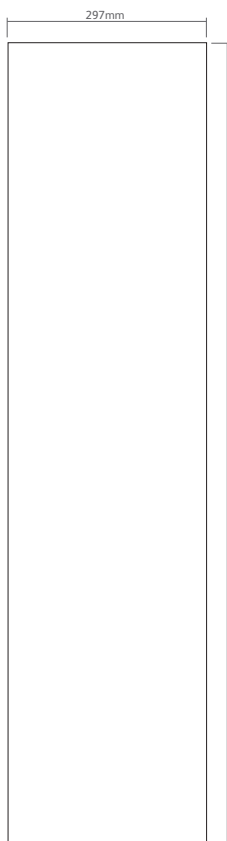

PRODUCT DETAILS

Xerox Product Code <b>003R95087</b>	Antalis Product Code <b>83804</b>	Description <b>1600 Totem Display Unit</b>
Supp Product Code <b>XT1600</b>		Insert Sheet Size <b>1600 x 495mm</b>
Supp Design No. <b>D6500</b>		Insert Paper <b>Not supplied</b>
Size <b>716(w) x 1613(h) x 444(d)mm</b>		Items Per Box: <b>x1 DISPLAY</b>
Cover Material <b>0.8mm CLEAR PET</b>		

PACKAGING DETAILS

Outer Case Design No. <b>D6465</b>	I.D. <b>1617 x 522 x 107mm</b>
Style <b>SLOTTED WRAP</b>	O.D. <b>1631 x 536 x 124mm</b>
Material <b>150KT BC FLUTE</b>	Case Weight <b>7.2 Kg</b>

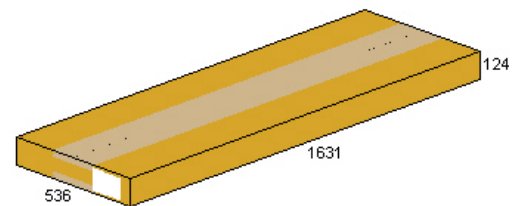

PALLETISATION DETAILS

UK Pallet 1200 x 1000mm

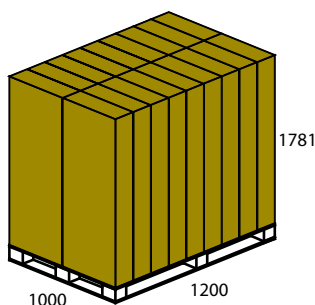

CASE LABELLING DETAILS

**xerox** 

Create Range  
1600 TOTEM DISPLAY

x1

No inserts



5 017534 950874

003R95087

7.2Kg  
MADE IN EU

Rows	Per rows	Total Cases
<b>2</b>	<b>9</b>	<b>18</b>
Items / Load		
<b>18 DISPLAYS</b>		
Load Weight (inc pallet)		
<b>137 Kg</b>		

Xerox: 003R98889

Specification Sheet

Antalis: 61208

PRODUCT DETAILS

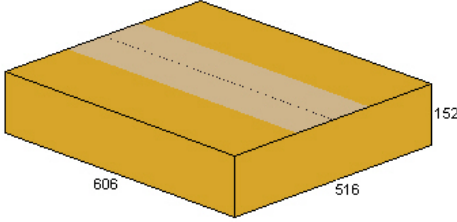
Xerox Product Code <b>003R98889</b>	Antalis Product Code <b>61208</b>	Description <b>Sample Pack of 26 Products</b>
Supp Product Code <b>XSS</b>		Insert Sheet Size *
Supp Design No. *		Insert Paper *
Size <b>590 x 500 x 120mm</b>		Items Per Box: <b>x26 SAMPLES</b> <b>INCLUDING PRINTED INSERTS</b>
Cover Material *		

PACKAGING DETAILS

Outer Case Design No. <b>D6723</b>	I.D. <b>590 x 500 x 120mm</b>
Style <b>0201 GLUED</b>	O.D. <b>606 x 516 x 152mm</b>
Material <b>150KT BC FLUTE</b>	Case Weight <b>5.5Kg</b>

PALLETISATION DETAILS

UK Pallet 1200 x 1000mm

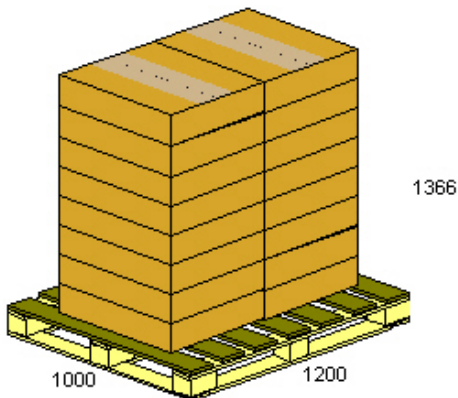

Cases / Layer <b>2</b>	Layers <b>8</b>	Total Cases <b>16</b>
Items / Load <b>16 SAMPLE SETS</b>		
Load Weight (inc pallet) <b>91Kg</b>		

CASE LABELLING DETAILS



Xerox: 003R90001

Specification Sheet

Antalis: 67186

PRODUCT DETAILS

Xerox Product Code <b>003R90001</b>	Antalis Product Code <b>67186</b>	Description <b>Create Free Standing Display Unit</b>
Supp Product Code <b>XFSDU</b>		Insert Sheet Size *
Supp Design No. *		Insert Paper *
Size <b>450 x 317 x 1493mm</b>		Items Per Box: <b>x1 FSDU</b> <b>(Sample set not included)</b>
Cover Material <b>190CLY/EB/180W</b>		

PACKAGING DETAILS

Outer Case Design No. <b>D6236</b>	I.D. <b>525 x 40 x 1503mm</b>
Style <b>0203 GLUED</b>	O.D. <b>541 x 56 x 1535mm</b>
Material <b>150KT BC FLUTE</b>	Case Weight <b>2.7Kg</b>

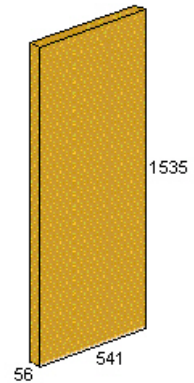

PALLETISATION DETAILS

UK Pallet 1200 x 1000mm

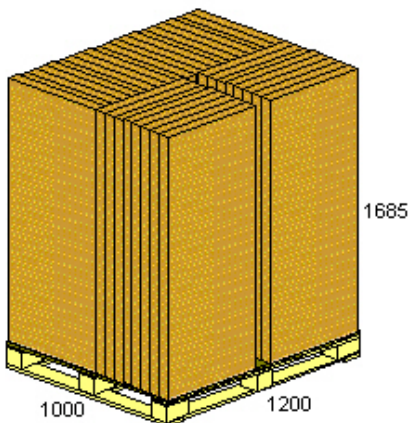

Cases / Layer	Layers	Total Cases
<b>37</b>	<b>1</b>	<b>37</b>
Items / Load <b>37 x FSDU</b>		
Load Weight (inc pallet) <b>124Kg</b>		

CASE LABELLING DETAILS



PRODUCT DETAILS

Xerox Product Code <b>003R91394</b>	Antalis Product Code <b>67184</b>	Description <b>Create Sample Set &amp; Free Standing Display Unit</b>
Supp Product Code <b>XFSDUSS</b>		Insert Sheet Size *
Supp Design No. *		Insert Paper *
Size <b>450 x 317 x 1493mm</b>		Items Per Box: <b>x1 FSDU x26 Sample Products</b>
Cover Material <b>190CLY/EB/180W</b>		

PACKAGING DETAILS

Outer Case Design No. <b>D6330</b>	I.D. <b>1500 x 523 x 150mm</b>
Style <b>TRAY &amp; LID</b>	O.D. <b>1542 x 555 x 158mm</b>
Material <b>150KT BC FLUTE</b>	Case Weight <b>8.8Kg</b>

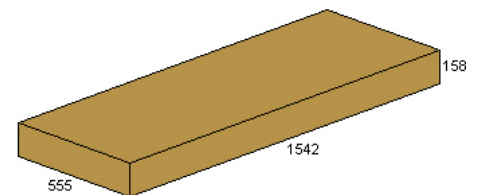

PALLETISATION DETAILS

UK Pallet 1200 x 1000mm
-------------------------

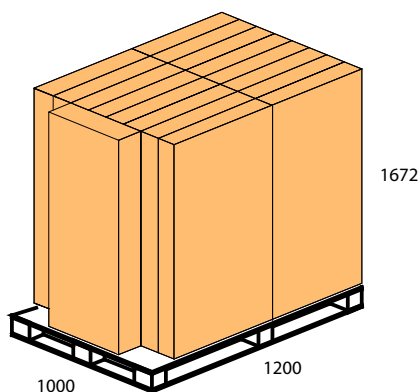

CASE LABELLING DETAILS

**xerox** 

Create Range  
SAMPLE PACK (26 PRODUCTS)  
& DISPLAY UNIT

**x1 set**

  
5017534913947

8.8Kg  
MADE IN EU

# 003R91394

Row	Layers	Total Cases
	<b>1</b>	<b>17</b>
Items / Load		
<b>17 x SETS</b>		
Load Weight (inc pallet)		
<b>157Kg</b>		



Boxed in 50's

Large Boutique Bag

**003R98797**

Frosted bag with white rope handles.

320 x 400 x 130mm



Boxed in 50's

Small Boutique Bag

**003R98796**

Frosted bag with white rope handles

260 x 323 x 100mm



Boxed in 50's

Extra Small Boutique Bag

**003R98876**

Frosted bag with white rope handles

190 x 236 x 70mm



Boxed in 100's

Bottle Gift Bag

**003R95563**

Frosted bag with white rope handles

100 x 350 x 100mm



Boxed in 20's

Magazine File

**003R98871**

Flat packed. Easy 3 piece self assembly.



Boxed in 20's

'X File' A4 Ring Binder 25mm

**003R98887**

4D ring 25mm capacity



Boxed in 25's

A4 Ring Binder 40mm

**003R98884**

2D ring 40mm capacity



Boxed in 25's

'Tuff' A4 Ring Binder 25mm

**003R98882**

4D ring 25mm capacity with full display pocket to front & spine



Boxed in 25's

'Tuff' A4 Ring Binder 25mm

**003R98886**

4D ring 25mm capacity with A4 display pocket to front & spine



Boxed in 50's

A4 Ring Binder 11mm

**003R98874**

4D ring 11mm capacity



Boxed in 50's

A4 Ring Binder 25mm

**003R98875**

4D ring 25mm capacity



Boxed in 50's

A5 Ring Binder 35mm

**003R98885**

2D ring 35mm capacity



Boxed in 50's

A4 Flat Folder

**003R98799**

A4 cover display pocket



Boxed in 50's

A4 File Box 20mm

**003R98873**

Display pocket to front and spine



Boxed in 50's

A4 File Box 40mm

**003R98872**

Display pocket to front and spine



Boxed in 100's

A4 Landscape Flat Folder

**003R93542**

Landscape document folder



Boxed in 50's

A4 Coil / Wiro Cover

**003R98888**

Ready to be punched with A4 documents



Boxed in 50's

A4 Letter File

**003R98879**

A4 cover display pocket



Mouse Mat  
**003R98798**

Scratch resistant surface. Optional adhesive taped closure.

Boxed in 50's



A3 Mat  
**003R98883**

Scratch resistant surface. Optional adhesive taped closure.

Boxed in 75's



Square Coaster  
**003R98877**

2 piece injection moulded clear coaster.

Boxed in 200's



30cm Ruler  
**003R98878**

2 piece injection moulded clear ruler.

Boxed in 100's



Name Plate Display  
**003R93575**

Quarter fold A4 display area to front and back

Boxed in 50's



A4 Leaflet Dispenser  
**003R98881**

40mm capacity A4 leaflet holder

Boxed in 50's



A4 Display Unit  
**003R98880**

Double sided A4 display unit

Boxed in 20's



A4 Window Display  
**003R95783**

Supplied with suction cups for easy positioning

Boxed in 10's



Full Range Sample Set  
**003R98889**

A boxed set of 26 Create Range products



Create Range FSDU  
**003R90001**

Floor standing display unit. Note: samples not included



FSDU Plus Full Sample Set  
**003R91394**

Floor standing display unit including a full set of samples



## Quick Change Totem Display Units

With a high gloss finish and easy assembly from flat, these totem display units can be quickly installed and produce stunning double sided print visibility.

Part No.	Paper size
003R98880	297 x 210mm (A4)
003R95083	420 x 297mm (A3)
003R95084	660 x 364mm (iGen)
003R95085	900 x 210mm
003R95086	1200 x 297mm
003R95087	1600 x 495mm







Mouse Mat  
**003R98798**

Scratch resistant surface. Optional adhesive taped closure.

Boxed in 50's



A3 Mat  
**003R98883**

Scratch resistant surface. Optional adhesive taped closure.

Boxed in 75's



Square Coaster  
**003R98877**

2 piece injection moulded clear coaster.

Boxed in 200's



30cm Ruler  
**003R98878**

2 piece injection moulded clear ruler.

Boxed in 100's



Name Plate Display  
**003R93575**

Quarter fold A4 display area to front and back

Boxed in 50's



A4 Leaflet Dispenser  
**003R98881**

40mm capacity A4 leaflet holder

Boxed in 50's



A4 Display Unit  
**003R98880**

Double sided A4 display unit

Boxed in 20's



A4 Window Display  
**003R95783**

Supplied with suction cups for easy positioning

Boxed in 10's



Full Range Sample Set  
**003R98889**

A boxed set of 26 Create Range products



Create Range FSDU  
**003R90001**

Floor standing display unit. Note: samples not included



FSDU Plus Full Sample Set  
**003R91394**

Floor standing display unit including a full set of samples

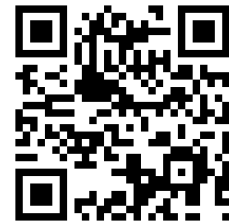

## Quick Change Totem Display Units

With a high gloss finish and easy assembly from flat, these totem display units can be quickly installed and produce stunning double sided print visibility.

Part No.	Paper size
003R98880	297 x 210mm (A4)
003R95083	420 x 297mm (A3)
003R95084	660 x 364mm (iGen)
003R95085	900 x 210mm
003R95086	1200 x 297mm
003R95087	1600 x 495mm

